



City of Cockburn

Signage Style Guide

Version control

Date	Description	Who
June 2017	Multiple, feedback after launch	S.Seymour-Eyles
June 2018	10.5.1 Smoke Free addition, 5.1 street names and 8.0 Interpretive signage (work in progress)	S.Seymour-Eyles
September 2018	8.0 Interpretive signage	S.Seymour-Eyles
September 2018	11.0 Regulatory signage position of logo amended to left side	S.Seymour-Eyles
March 2019	6.0 Internal/external wayfinding B Orange strip added to left side	S.Seymour-Eyles
March 2019	8.0 Interpretive signs 400mm (w) x 300mm (h) signage added	S.Seymour-Eyles
August 2019	P44 Facility plaques, P48-53 Park and amenity signs, P59-60 Interpretive signs	S.Seymour-Eyles
January 2020	P63 Project signs updated	S.Seymour-Eyles
February 2020	P59, 60 - 8.0 Interpretive signage - added Cockburn Central West Memorial Walk Signage	S.Seymour-Eyles
February 2020	P22 Cockburn community signs - Orange strip moved	S.Seymour-Eyles
June 2020	P47, 48 And 49 Added Regional parks designated Symbol/Logo	S.Seymour-Eyles
July 2020	P57 Added Writing Guide and P85 Added Permit icons	S.Seymour-Eyles
September 2020	P87 Added Dog permission icons - Traffic light style signage system	S.Seymour-Eyles
May 2021	P48 Secondary Park Entry Sign A - Size updated	Nam Luu
July 2021	11.7 Car Parks - Updated	Nam Luu
July 2021	P44 Rework FACILITY PLAQUES to Facility and other plaques	S.Seymour-Eyles
July 2022	Added new section 7.9 Boundary Access Signage P56 and 7.10 Dieback Protection Area Sign P57	Nam Luu
May 2023	Proud to be smoke-free Sign	Nam Luu
June 2023	P48 Carpark text removed	Nam Luu
December 2023	P88 No Truck Parking icon added	Nam Luu
May 2024	P78 Shared Path Sign added	Nam Luu
July 2024	P88 Golf Allowed icon added and P 89 Flying fox icon added	Nam Luu
August 2024	P59 text added and Community Development Manager change to: First Nations Community Development Officer/Manager various pages	Nam Luu
March 2025	Page 5: Inserted "Internal asset register" column	Nam Luu
April 2025	Vape/smoking icon updated and CCTV icon and wording added	Nam Luu

1.0 General information	4	7.0 Parks and amenity signs	45	12.0 Waste	79
1.1 Sample location map	6	7.1 Primary park entry sign	47	12.1 Bin labels	80
1.2 The logo	7	7.2 Secondary park entry sign A	48	12.2 Rubbish truck signage	81
1.3 The logo – incorrect usage	8	7.3 Secondary park entry sign B	49		
1.4 Signage colour palette	9	7.4 Primary park information sign	50	13.0 Symbols	82
1.5 Typefaces	10	7.5 Location park information sign	51	13.1 Using symbols	83
1.6 Directional arrows	11	7.6 Park wayfinding sign A	52	13.2 General toilet/changeroom signage	85
1.7 The wave - supporting graphic	12	7.6 Park wayfinding sign B	53	13.3 Leisure centre toilet/changeroom signage	86
2.0 Entry/welcome signs	13	7.7 Park event a frame	54	13.4 Symbols used for wayfinding including road traffic and pedestrian signage	87
2.1 Totem entry signage	15	7.8 Park foot path stencil	55	13.4 Symbols used for wayfinding including road traffic and pedestrian signage	88
2.2 Secondary entry signage	16	7.9 Boundary access sign	56	13.6 Prohibitive icons	89
2.3 Secondary entry signage – suburb	17	7.10 Dieback protection area sign	57	13.7 Permitted icons	90
3.0 Regional sports facilities	18			13.8 Warning icons	90
3.1 Sports facility signs with address and multiple clubs/businesses	20	8.0 Interpretive signs	58	13.9 Dog permission icons	91
4.0 Community groups	21	8.1 Interpretive signage	61	13.10 CCTV icon	92
4.1 Cockburn community signs	22	8.1 Interpretive sign types	62		
5.0 Wayfinding signs	23	9.0 Project signs	63		
5.1 Fingerboard street name signs	26	9.1 Project signs	64		
5.2 Fingerboard street name signs with poppy	27	10.0 Beach warning, access and directional signs	65		
5.3 Community facility name signs	28	10.1 Beach hazard signs	67		
5.4 Facility directional sign proportions	29	10.2 Beach closure/access and directional signage	68		
5.4 Facility directional sign types	30	11.0 Regulatory signs	69		
5.5 Facility directional sign typeface sizes	31	11.1 Cosafe security sign	70		
5.6 Facility pedestrian wayfinding sign A	32	11.2 Dog related signs	71		
5.7 Facility pedestrian wayfinding sign B	33	11.3 Poo-ch pouch signs	72		
5.8 Facility pedestrian wayfinding sign C multiple locations	34	11.4 Activities not permitted	73		
6.0 Facility and building signs	35	11.5 Health warnings	74		
6.1 Facility building sign A	37	11.6 On-street parking	75		
6.2 Secondary facility entry sign	38	11.7 Car parks	76		
6.3 Information entry sign	39	11.8 Proud to be smoke-free sign	77		
6.4 Internal/external wayfinding signs type A and B	40	11.9 Shared path sign	78		
6.4 Internal/external wayfinding signs type C	41				
6.4 Internal/external wayfinding signs type D title and name	42				
6.5 Water parks	43				
6.6 Facility and other plaques	44				

1.0 General information



This document has been designed to provide simple guidelines to assist and improve signage and branding within the locality of City of Cockburn and within its buildings and facilities.

This signage style guide contains information on the proper and consistent application of signage within City of Cockburn. The guidelines are to be used by City of Cockburn officers and signage contractors for all City of Cockburn signage. All visual design work for the City of Cockburn must comply with the relevant sections of the “accessible information” section of the State (Western Australian) Government “Access Guidelines for Information Services and Facilities (a guide to assist government, business and community groups to create Western Australia as an accessible and inclusive community)”, the “Accessible Information: Policy and Guidelines for Local Government” and the Association for the Blind of WA (Inc) “General Guidelines for Accessible Print”.

These guidelines must be used in conjunction with the following **City of Cockburn policy and procedure documents**:

1. City of Cockburn Corporate Style Guide
2. City of Cockburn Writing Style Guide.

Codes and Standards

All work and materials shall, except where otherwise noted on the drawings or directed in the specifications, comply with the latest editions of all relevant Australian codes or Australian Standards (AS).

See section 9.0 Symbols for information on using Australian Standard symbols in City of Cockburn signage.

New sign / damaged sign procedure

Refer to
[DOC Set ID 4708157](#)

External management

Architect/builder provides sign artwork using this Style Guide



Send communications (Graphic Design) proof of new signs for review of copy and layout



Production

Interpretive sign procedure

Refer to
[DOC Set ID 4708157](#)

Internal asset register

Location, style, photograph and cost of sign



assets@cockburn.wa.gov.au

This applies to upgrades, new signs and rationalisation.

1.1 Sample location map

This map shows how different types of sign are used across the City's local area for branding, wayfinding, information and identification.

The City of Cockburn's administration site has been used to illustrate how the different types of signs are used.

- A** Large vehicle Wayfinding signs
- B** Medium vehicle Wayfinding signs
- C** Pedestrian Wayfinding signs
- D** Pedestrian Wayfinding signs
- E** Pedestrian Wayfinding signs
- F** Facility entry signs



1.2 The logo

The logo is a specially designed mark and must not be typeset, traced, respaced, redrawn or modified in any form by either manual or electronic methods.

The proportions, spacing, relative positioning and colour of the logo must remain consistent.

The logo must never be used in any other relationship other than the one in these guidelines. The logo can appear with and without the tagline. As a general rule though the logo with the tagline is used. Applications where the tagline is not used are noted throughout this document.

Note: Generally in signage applications the city of Cockburn logo with 'Wetlands to waves' tagline should be used at all times. Only in instances when the logo is reduced to a very small size should the tagline be dropped. Please refer to City of Cockburn corporate styleguide for minimum size application.

Usage

Use the Primary Logo (no tagline) when correct reproduction of the tagline text is impeded e.g the logo is reproduced at small size and may not be easily read



With tagline



Without tagline

1.3 The logo – incorrect usage

The examples here demonstrate some further typical graphic mistreatments of the City of Cockburn logo.

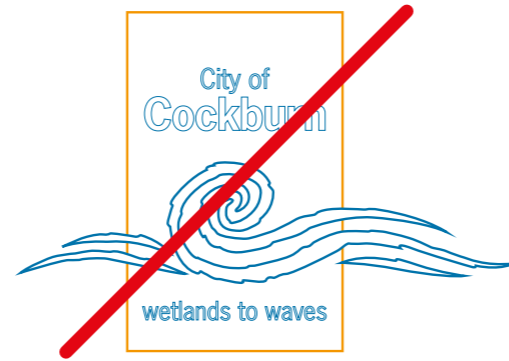

Do not keyline the logo



Do not alter the fonts



Do not compress the logo



Do not distort the logo



Do not apply a drop shadow



Do not stretch the logo



Do not add any elements



Do not rotate the logo



Do not use in low resolution

1.4 Signage colour palette

The colour breakdowns are as follows:

Note: Powder coating dependant on location conditions.

Two pack paint can be used as an alternative.

Signage panel colours

These colours are used on all City of Cockburn signage.

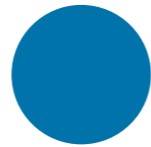

Pantone 307 CP
100C 22M 2Y 18K



Pantone 144 CP
0C 51M 100Y 0K

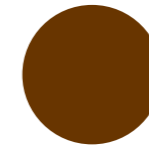

Pantone 7568 CP
15C 67M 100Y 65K



Pantone COOL GRAY 4
0C 0M 0Y 24K

Generic pole colour

These colours are used on all City of Cockburn signage poles.



Pantone COOL GRAY 4
0C 0M 0Y 24K

1.5 Typefaces

For legibility and clarity, **News Gothic Com (from the News Gothic)** is the recommended typeface to be used on all signage.

All type should be left aligned, unless indicated for specific signage within this document. Never use a justified setting for type.

Wherever possible, News Gothic Com Roman should be used for headline text and appear prominently.

Upper and lower case type should be used at all times for signs.

Stencil typeface

For information and directional footpath signage use Allerta Stencil. A Copy of the typeface is available from Corporate Communications, Graphic Design.

Headings/titles

For all headings and titles of City of Cockburn signage **News Gothic Com Medium** must be used.

ABCDEFGHIJKLMNOPQRSTUVWXYZ

abcdefghijklmnopqrstuvwxyz

0123456789

Sub heading

For all sub heading of City of Cockburn signage **News Gothic Com Roman** must be used.

ABCDEFGHIJKLMNOPQRSTUVWXYZ

abcdefghijklmnopqrstuvwxyz

0123456789

Body copy

For all body copy of City of Cockburn signage **News Gothic Com Light** must be used.

ABCDEFGHIJKLMNOPQRSTUVWXYZ

abcdefghijklmnopqrstuvwxyz

0123456789

Deciding text size

Although all of the text sizes are set in this style guide, they should be scaled to suit the application. Use your discretion when sizing type.

The minimum size that the fonts should be is 12pt. This size is only to be used in select instances when there is a larger amount of information displayed within a smaller area such as details on interpretive maps.

Line spacing

For optimum legibility, we advise that ample line spacing/leading be created between each line of text.

For all text with a size of 200pt must have space with 200pt leading.

For all body copy a normal x-height is required.

Tracking/letter spacing

For optimum legibility, it is advised that tracking/letter spacing is set to "optical, not "metrics".

1.6 Directional arrows

Pedestrians will never be directed to facilities which are situated behind them due to misinterpretation and confusing. The City of Cockburn signage will only use forwards, left, right and 45° angles arrows on their signage.

Correct arrows to use:

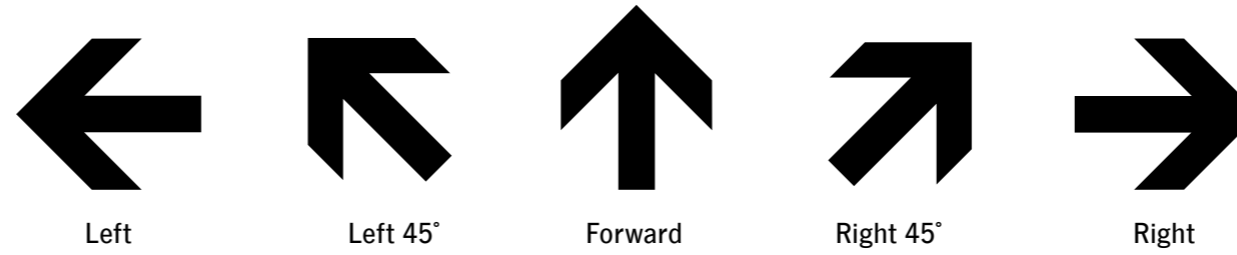

Correct arrows to use:



1.7 The wave - supporting graphic

The supporting graphic for the City of Cockburn signage is the wave, it will be laser cut or vinyl stickers onto all necessary signs.

The usage will depend on the type of sign used, on most flat panel signs the pattern will appear but on signage with curved surfaces you must follow the construction guidelines for that signage.

When the pattern is placed on signage it must have either a 50mm or 100mm clearance all round. This will be specified on the individual pages where the wave applies.

The wave can only be used for 5.0 Wayfinding signage, specifically for 5.3, 5.4 and 5.5 sign types.

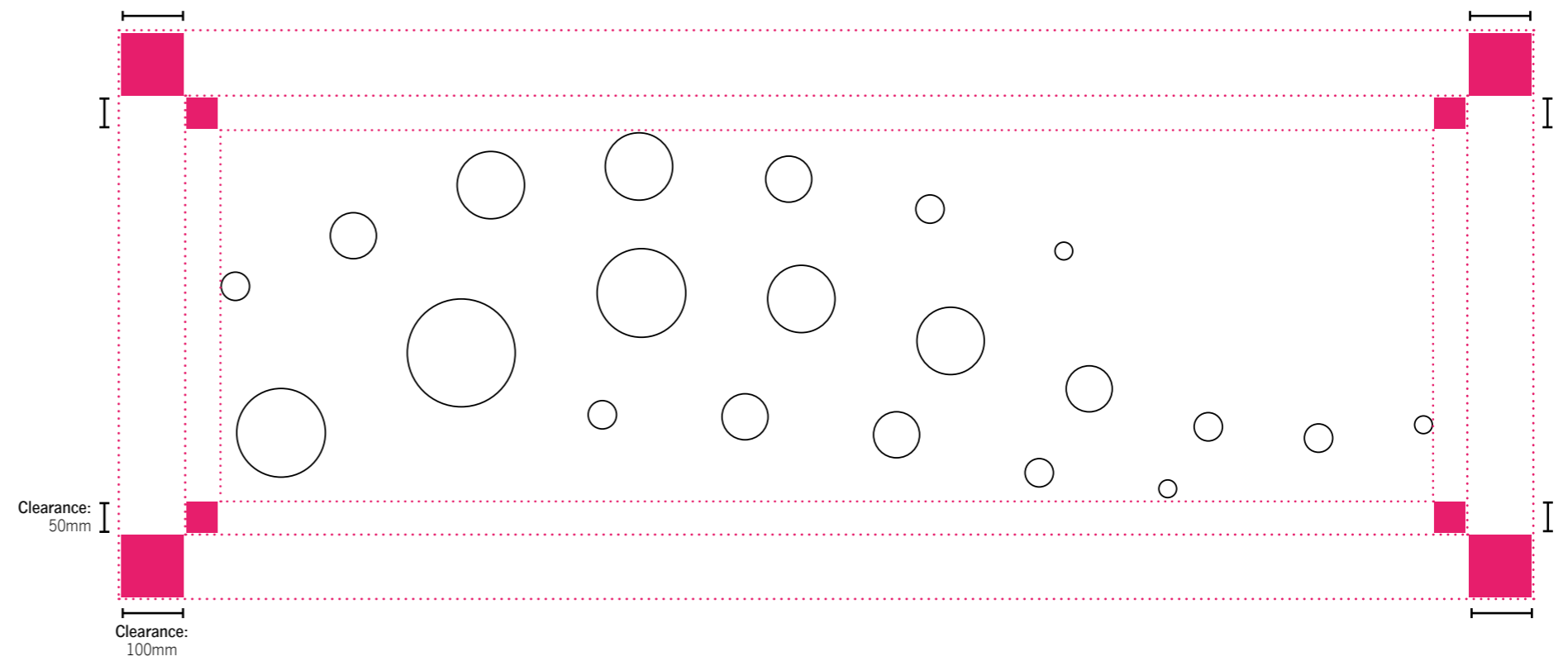

2.0 Entry/welcome signs



Structure for Entry/welcome signs

Below is a list and sizes of all the entry / welcome signs for the City of Cockburn.

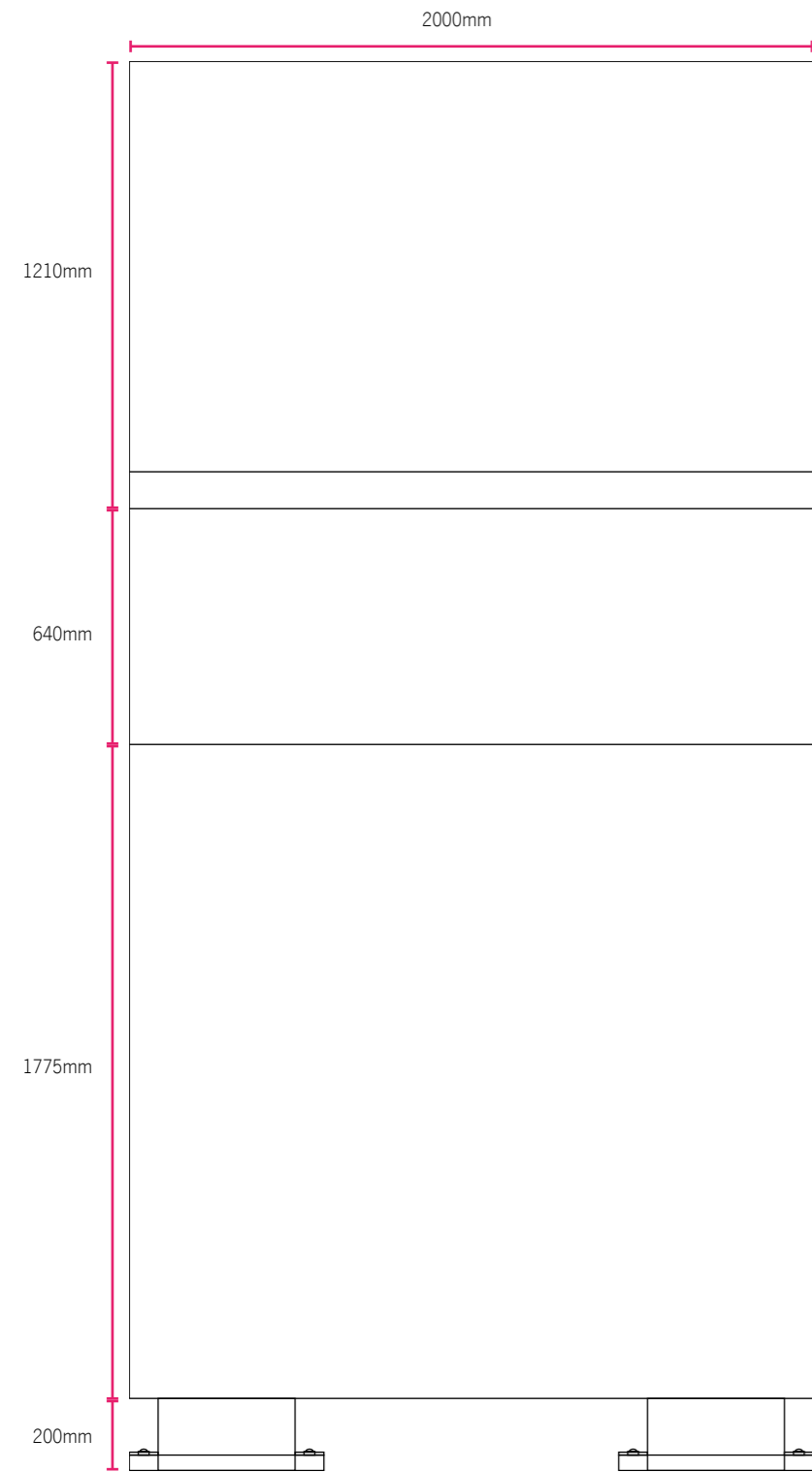

Digital totem signage

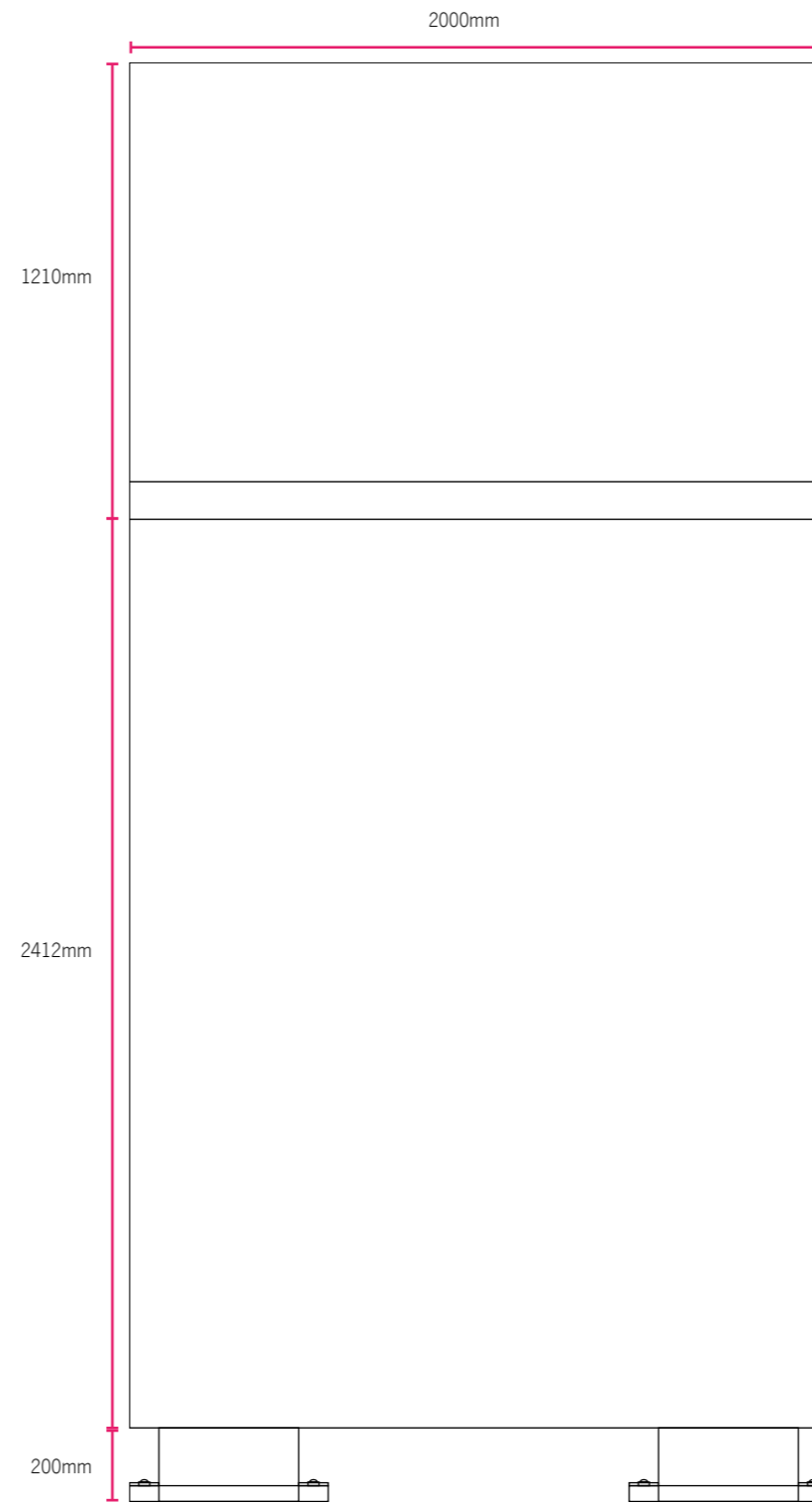

Totem signage

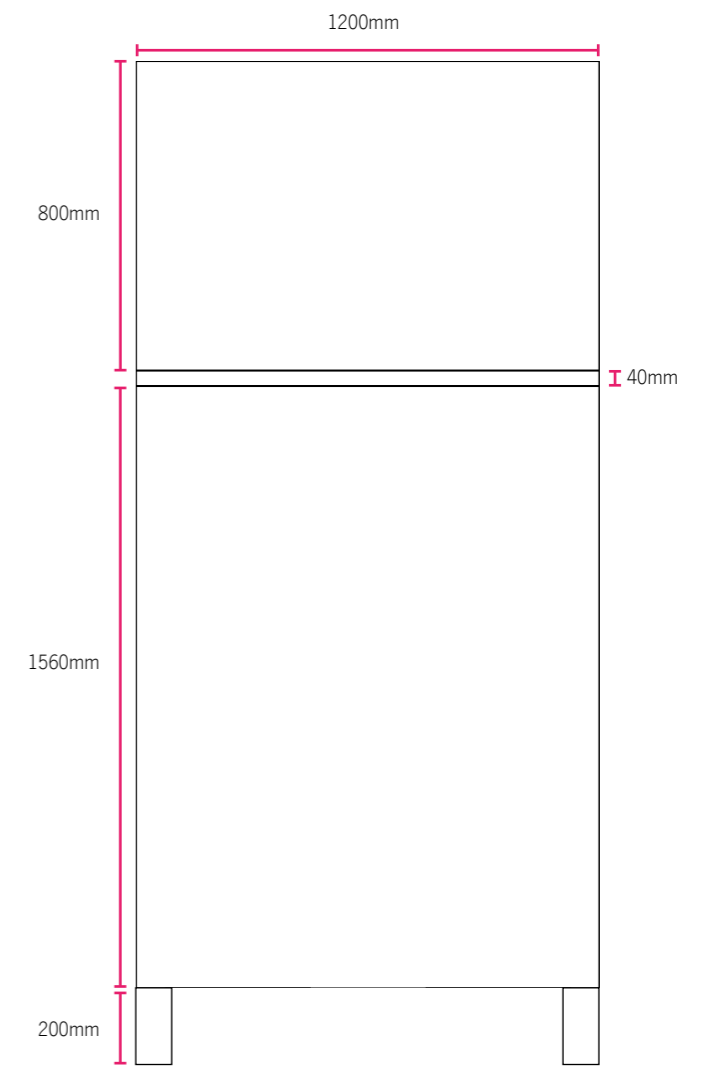

Secondary entry signage

2.1 Totem entry signage

Totem entry signs are to be used at the City of Cockburn boundary on main/arterial roads. They will have a digital display screens on which you will be able to see messages about or from the City of Cockburn.

Each sign includes:

- City of Cockburn logo
- Positioning statement
- Welcome message

Dimensions

1855mm (w) x 3820mm (h)

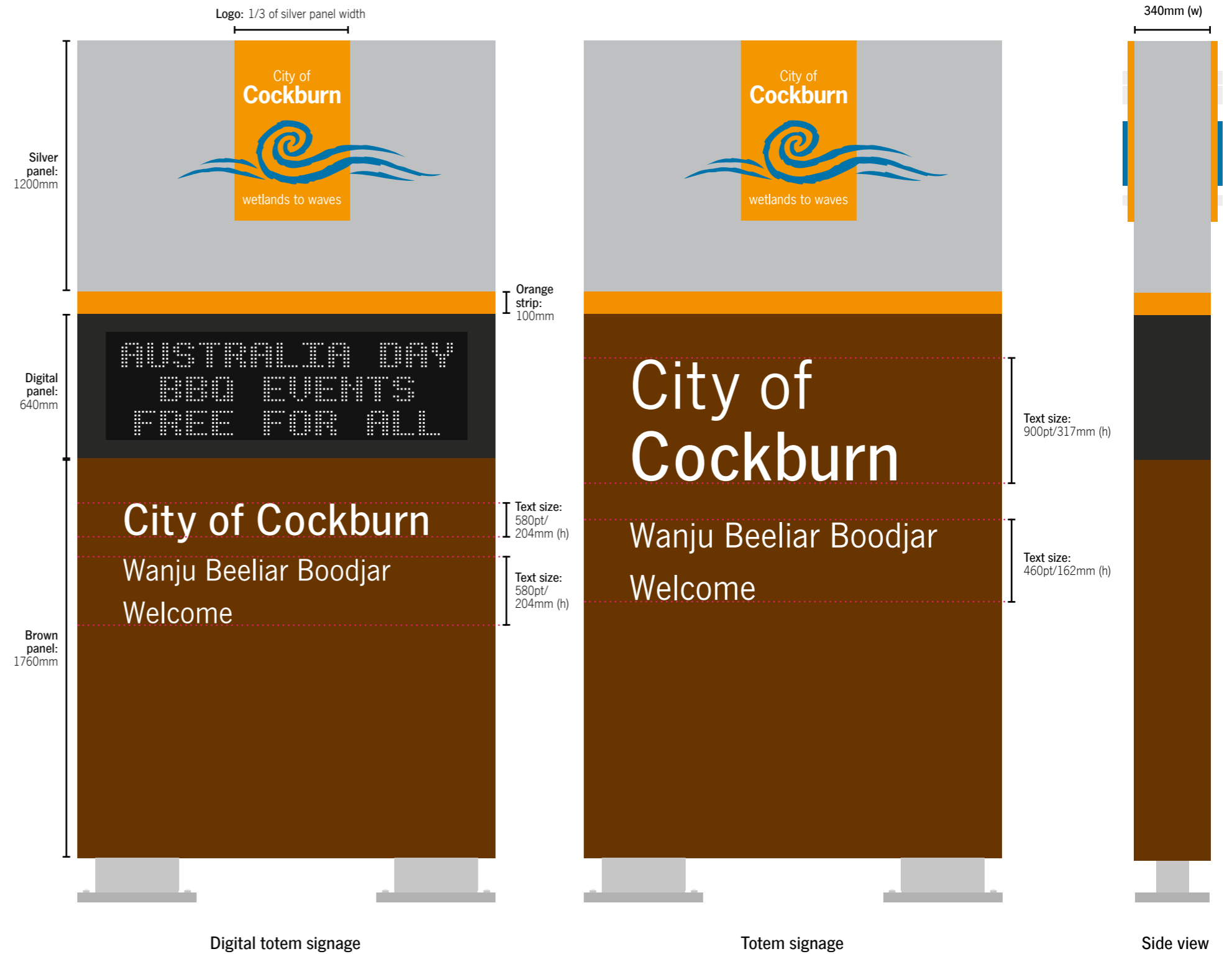

2.2 Secondary entry signage

Secondary entry/welcome signs are to be used at the City of Cockburn secondary road boundaries. They will also be used at internal suburb boundaries. They can also be used at the entrance to larger facilities. These signs can be used in either single sided or double sided applications.

Each sign includes:

- City of Cockburn logo
- Welcome message (includes English and Nyungar)
- Address

Dimensions

Sign face: 1100mm (w) x 2400mm (h)

Address information

Signage can include address details.

Park entry signs and building entry signs must include the address.

Check with Strategic Planning Services on the correct site address prior to fabrication.

Subdivision/developer entry signs

Parks accepts responsibility for estate signs if they are located in a road reserve or public open space and maintain them until the end of their life. It is then decided if they are replaced or not.



2.3 Secondary entry signage – suburb

Secondary entry/welcome signs for suburbs are to be used at the City of Cockburn secondary road boundaries. They will also be used at internal suburb boundaries. These signs can be used in either single sided or double sided applications.

Each sign includes:

- City of Cockburn logo
- Welcome message
- Address

Dimensions

Sign face: 1100mm (w) x 2400mm (h)

Address information

Signage can include address details.

Park entry signs and building entry signs must include the address.

Check with Strategic Planning Services on the correct site address prior to fabrication.

Subdivision/developer entry signs

Parks accepts responsibility for estate signs if they are located in a road reserve or public open space and maintain them until the end of their life. It is then decided if they are replaced or not.

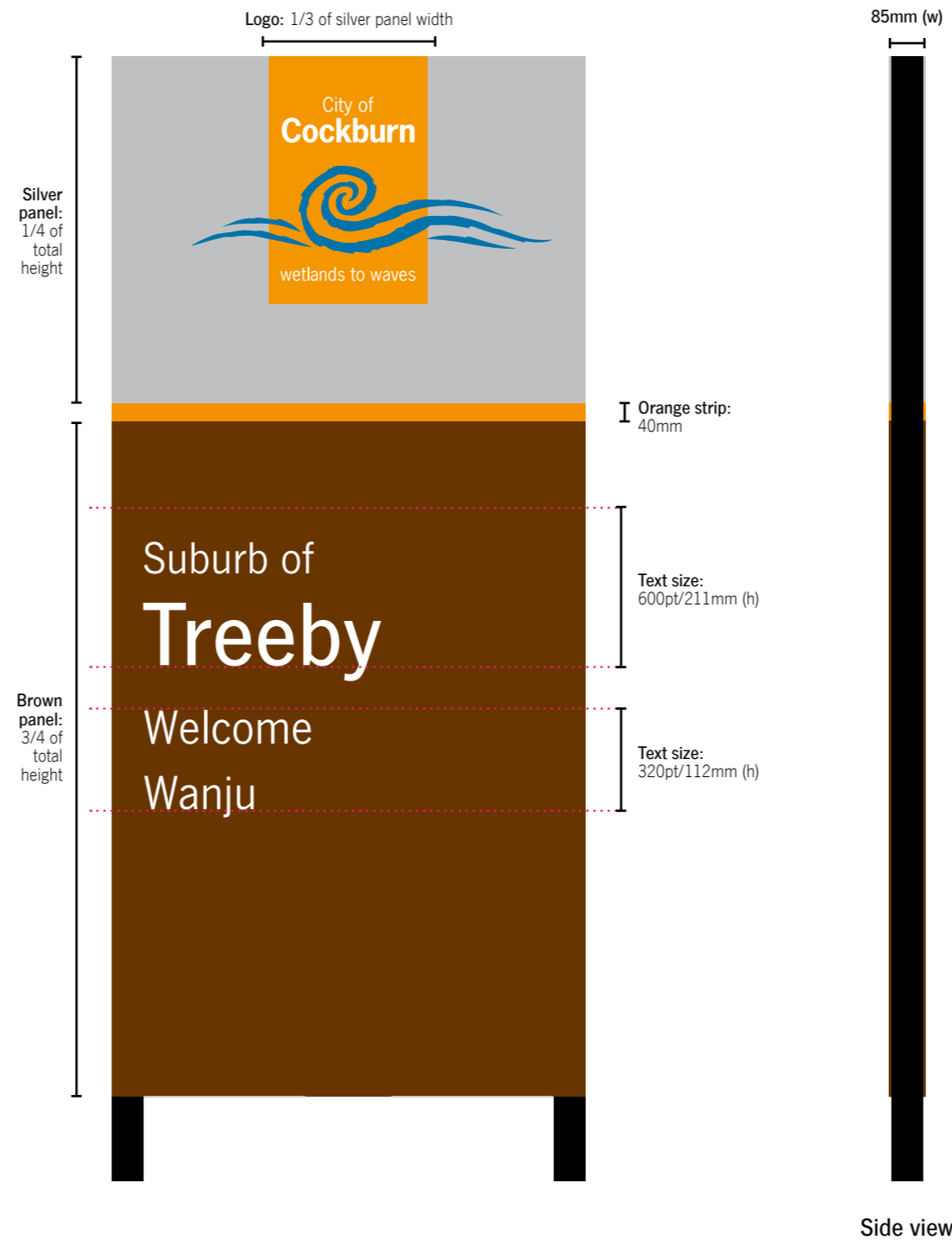

3.0 Regional sports facilities



3.1 Sports facility signs with address and multiple clubs/businesses

Sports facility signs will be used at City of Cockburn sports facilities or groups. They will have messages or names of groups or sports clubs close to the surrounding area, and can be used in either single or double sided.

Each sign includes:

- City of Cockburn colour palette
- Sports club, facility or landmark name/message
- Address if it is at a major entry on a road (see 7.2)

Dimensions

1100mm (w) x 2400mm (h)

Address information

Signage can include address details. Check with Strategic Planning Services on the correct site address prior to fabrication.

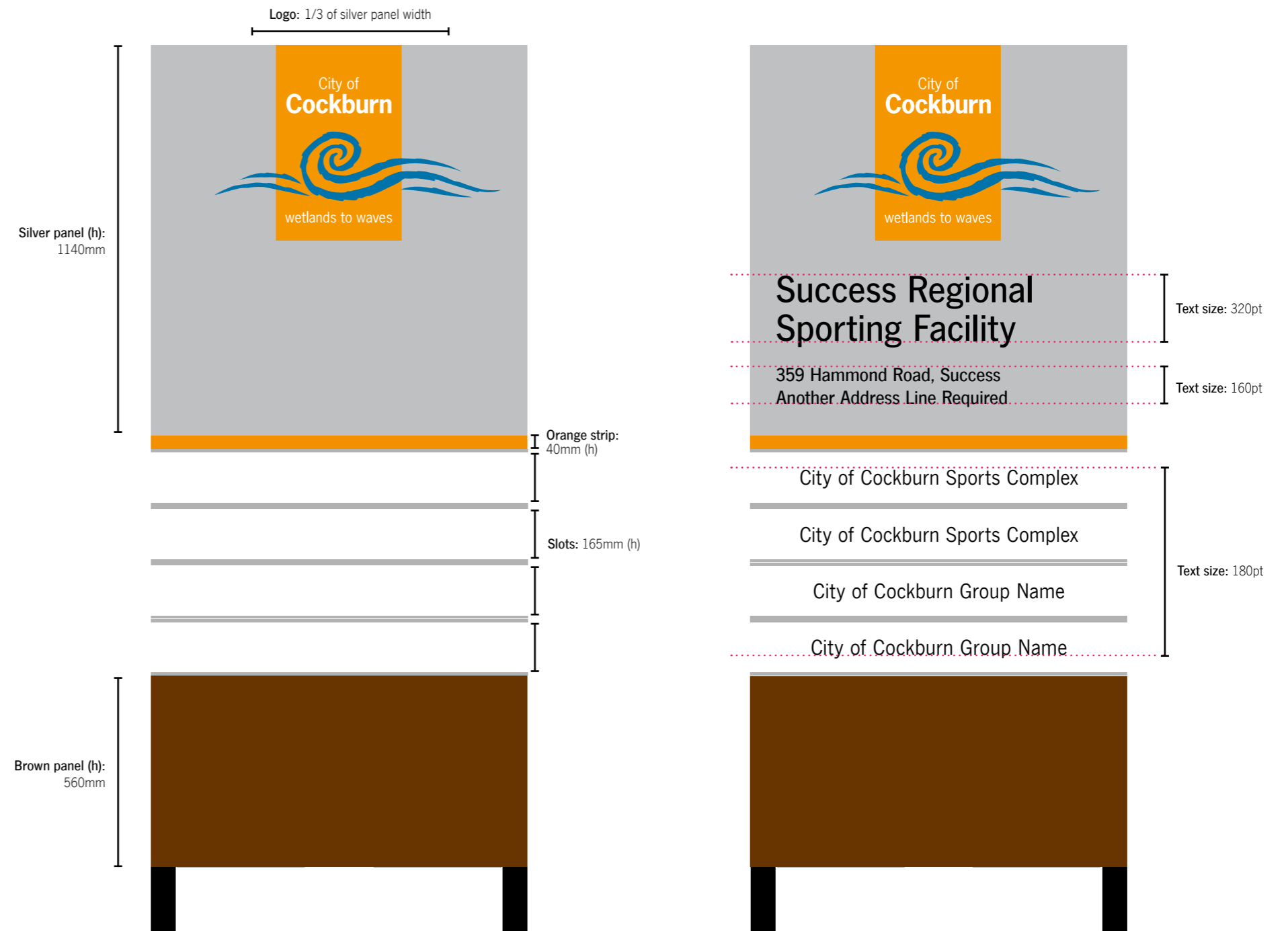

4.0 Community groups



4.1 Cockburn community signs

Cockburn community signs have been installed to promote non-commercial or non-political events and activities that benefit the community. The Community signs are the property of the City of Cockburn, but any or all of the 10 signs can be hired temporarily at no-cost by community groups, schools and registered charities - on approval from the City of Cockburn.

Dimensions

2300mm (w) x 3400mm (h)

Community sign

2300mm (w) x 1000mm (h)

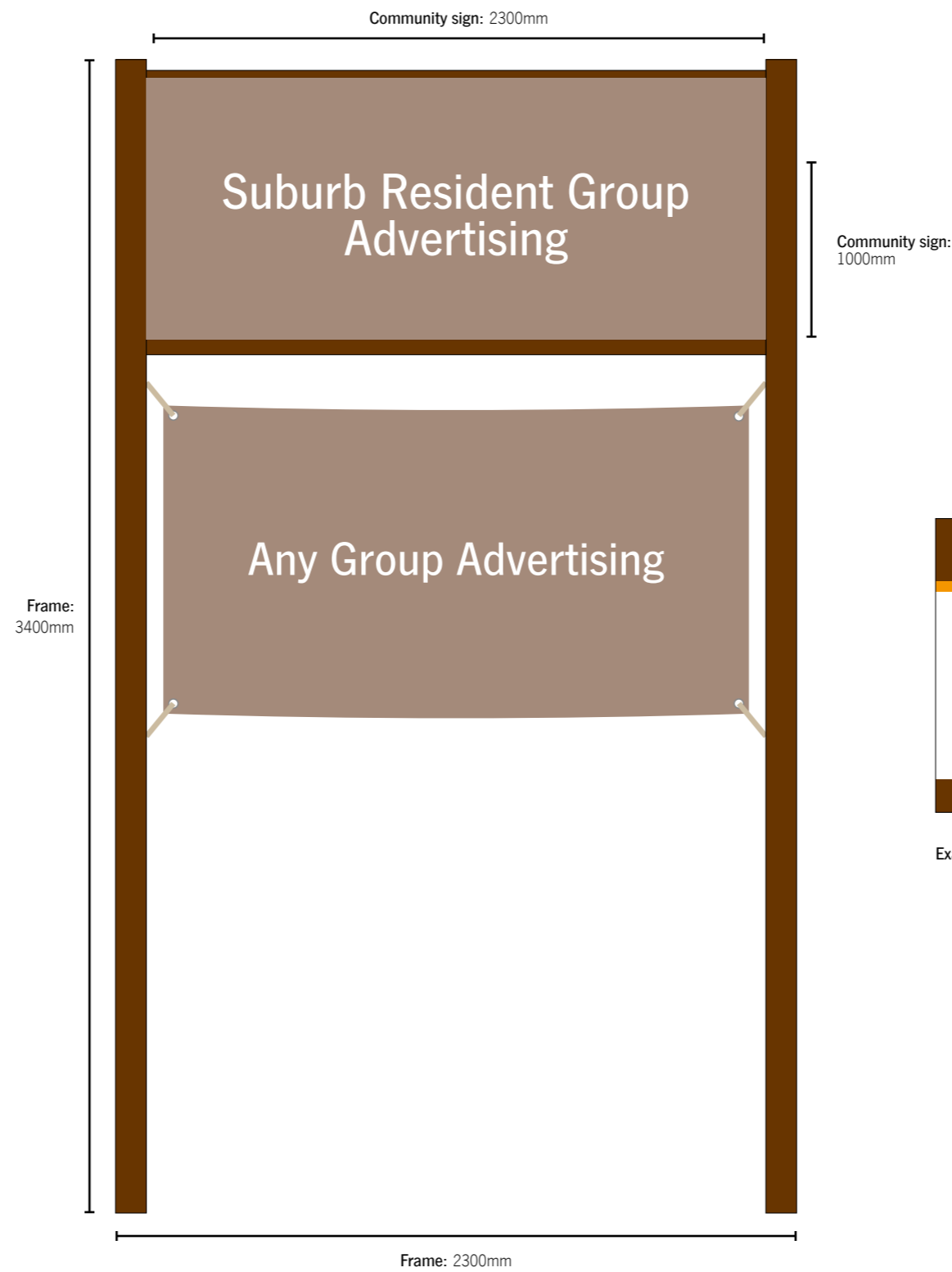

Examples

5.0 Wayfinding signs



The purpose of this section is to ensure that directional, service and tourist signage is effectively integrated into the urban landscape and the amenity of the locality is maintained and protected.

This procedure is a guide for City of Cockburn staff in assessing opportunities for signage rationalisation and internal and external requests for new signage.

Procedure

The City of Cockburn acknowledges the need to regulate signs on its road reserves, footpaths and public spaces to maintain the effectiveness of priority traffic control signs and directional signs and to ensure the amenity of the City of Cockburn is appropriate.

A reduction and limiting of the proliferation of road signs can preserve or enhance the aesthetic values of the landscape and environment. The use of Australian Standards and internationally recognised symbols on signs wherever possible can ensure simple, concise and consistent messages are conveyed to motorists and visitors.

Service and tourism directional fingerboard signs are to be in accordance with Australian Standard (AS) 1742.5 'Manual of uniform traffic control devices – Street name and Community facility name signs'.

Directional signs are signs erected in roads or public places to indicate the direction to places, services and tourist destinations within the City of Cockburn.

The purpose of tourism signs is to direct residents and visitors to services and attractions within City of Cockburn.

Directional signs not on a road name sign structure but proposed to stand alone will generally not be supported.

Refer to Engineering Services' Community Facility Name Sign guidelines for approval requirements.

This policy has been developed to ensure that the installation of signs is undertaken in a regulated and uniform manner, consistent with the requirements of other relevant authorities, including Main Roads Western Australia (MRWA).

Objectives

Provide an environment in which efficient placement of signs enhances a street, road reserve or precinct by increasing the overall impact and effectiveness of individual signs.

Provide clear and logical directional signs through the use of standardised dimensions, symbols and consistent colour coding, compliant with Australian Standards.

Ensure that directional signs throughout the City of Cockburn provide clear directions to community, service facilities and tourist destinations.

Provide traffic control signs that regulate, warn and guide traffic and facilitate safe, efficient and orderly travel.

Clearly identify those facilities that may qualify for directional signs and the conditions under which they may be permitted.

Structure for Wayfinding signs

Below is a list and sizes of all the Wayfinding signs for the City of Cockburn.

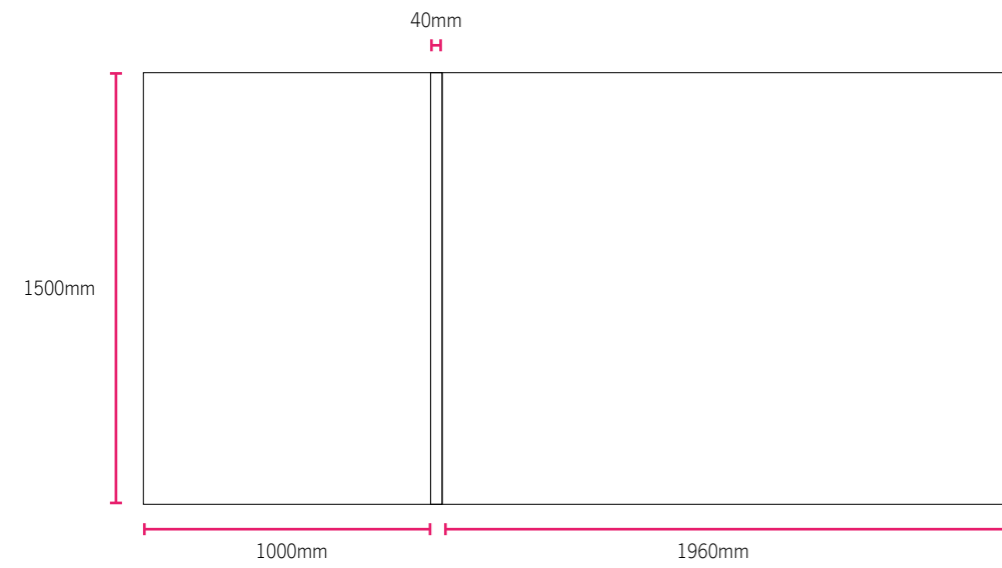

Type A

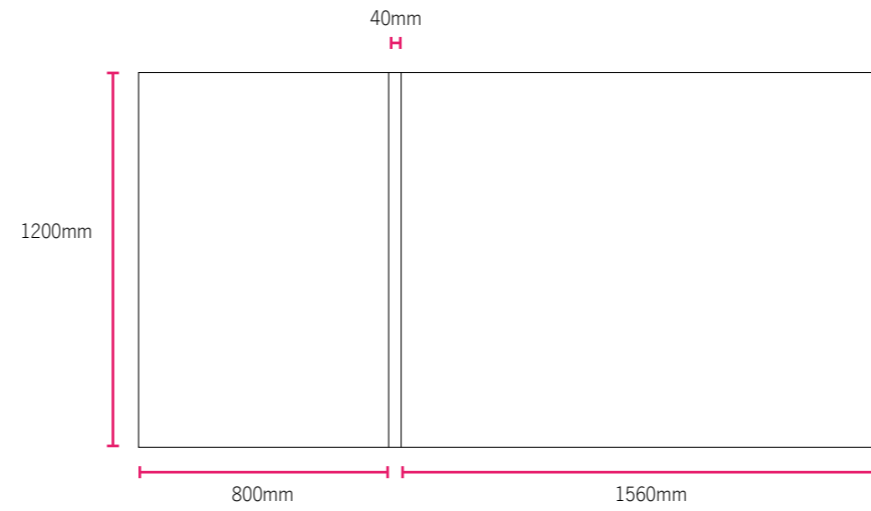

Type B

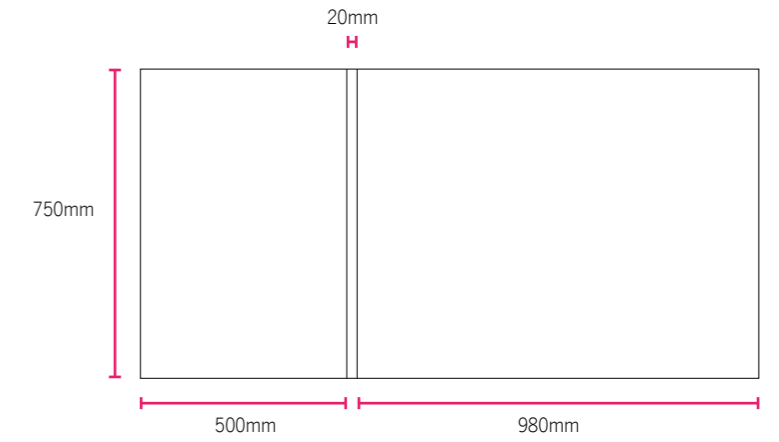

Type C

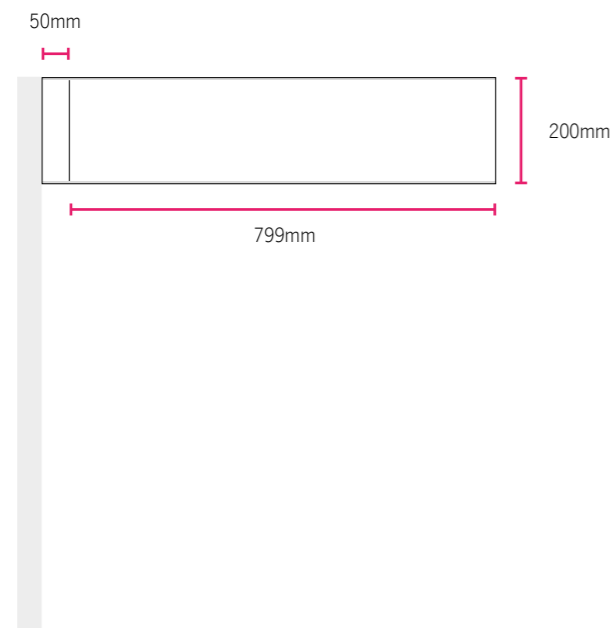

Street name fingerboard sign
Fingerboard public amenity sign

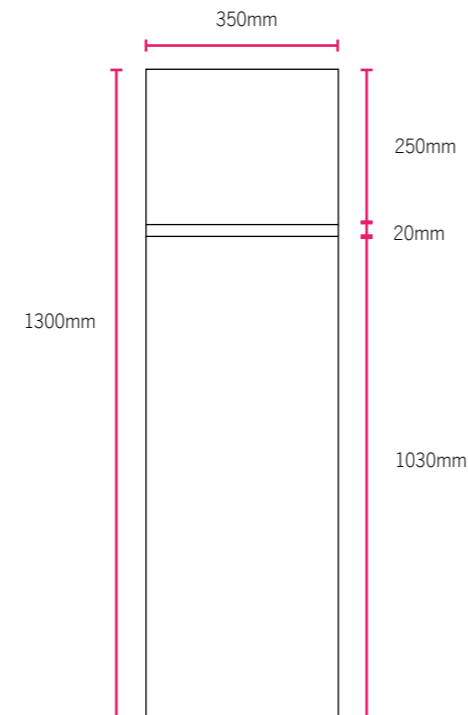

Facility pedestrian wayfinding sign A

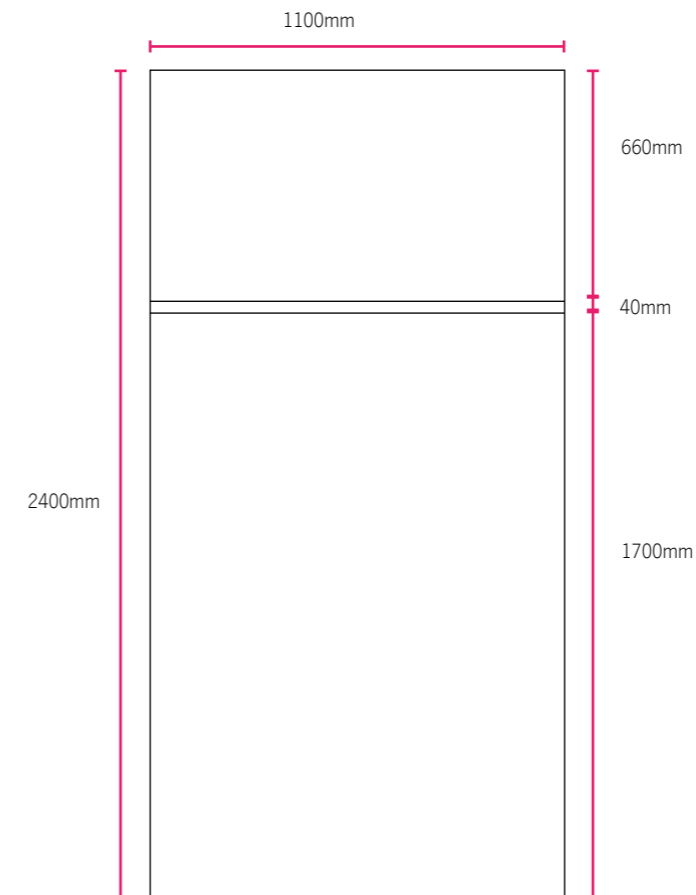

Facility pedestrian wayfinding sign B

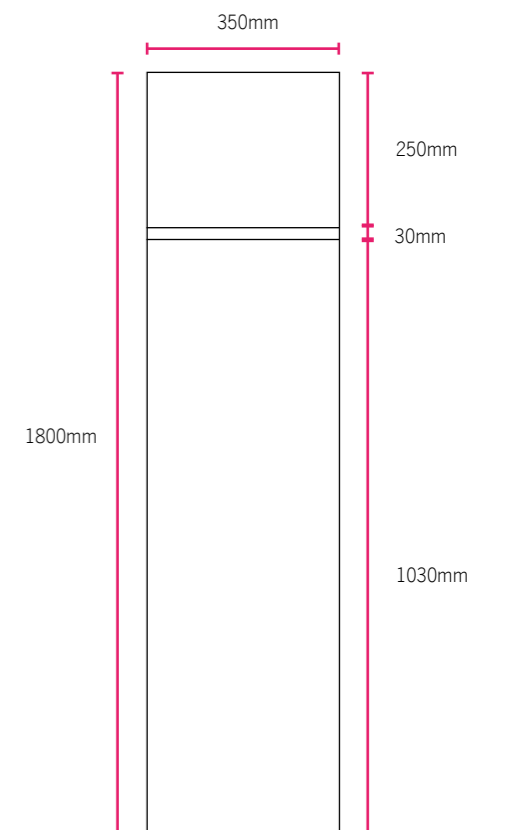

Facility pedestrian wayfinding sign C

5.1 Fingerboard street name signs

Layout

The following apply to fingerboard signs:

- Each individual sign is to incorporate the service and/or tourist feature/s, represented by a standard symbol where available, or standard text if necessary, and the directions to proceed.
- The use of Australian Standard service and tourist symbols is limited to five symbols per sign.
- In any one sign stack the maximum number of fingerboards is four, inclusive of the road name sign.
- Tourist and service signs shall have upper case lettering only using the Australian Standard (AS) 1744 Series standard font.
- For more information refer to Australian Standards.

Dimensions

Text: Refer to Australian Standard - Standard Alphabets for Road Signage AS 1744-1975 for details.

Sign face: Maximum length of 1500mm and height of 300mm. Each sign in a signage stack is to be 900mm, 1200mm or 1500mm in length, as determined by the text and or symbol on the sign.

Main Roads jurisdiction

Roads under jurisdiction or control of Main Roads WA are as follows:

- Kwinana Freeway
- Armadale Road (Kwinana Freeway to Armadale Boundary)
- Cockburn Road (Rockingham Road to Russell Road West)
- Rockingham Road (Stock Road to Kwinana Boundary)
- Russell Road West (Cockburn Road to Rockingham Road)
- Stock Road (Winterfold Road to Rockingham Road)

Note: Portions of Cockburn Road (Russell Road West to Kwinana Boundary), Rockingham Road (Cockburn Road to Stock Road) and Russell Road East (Rockingham Road to Kwinana Freeway) are City roads.

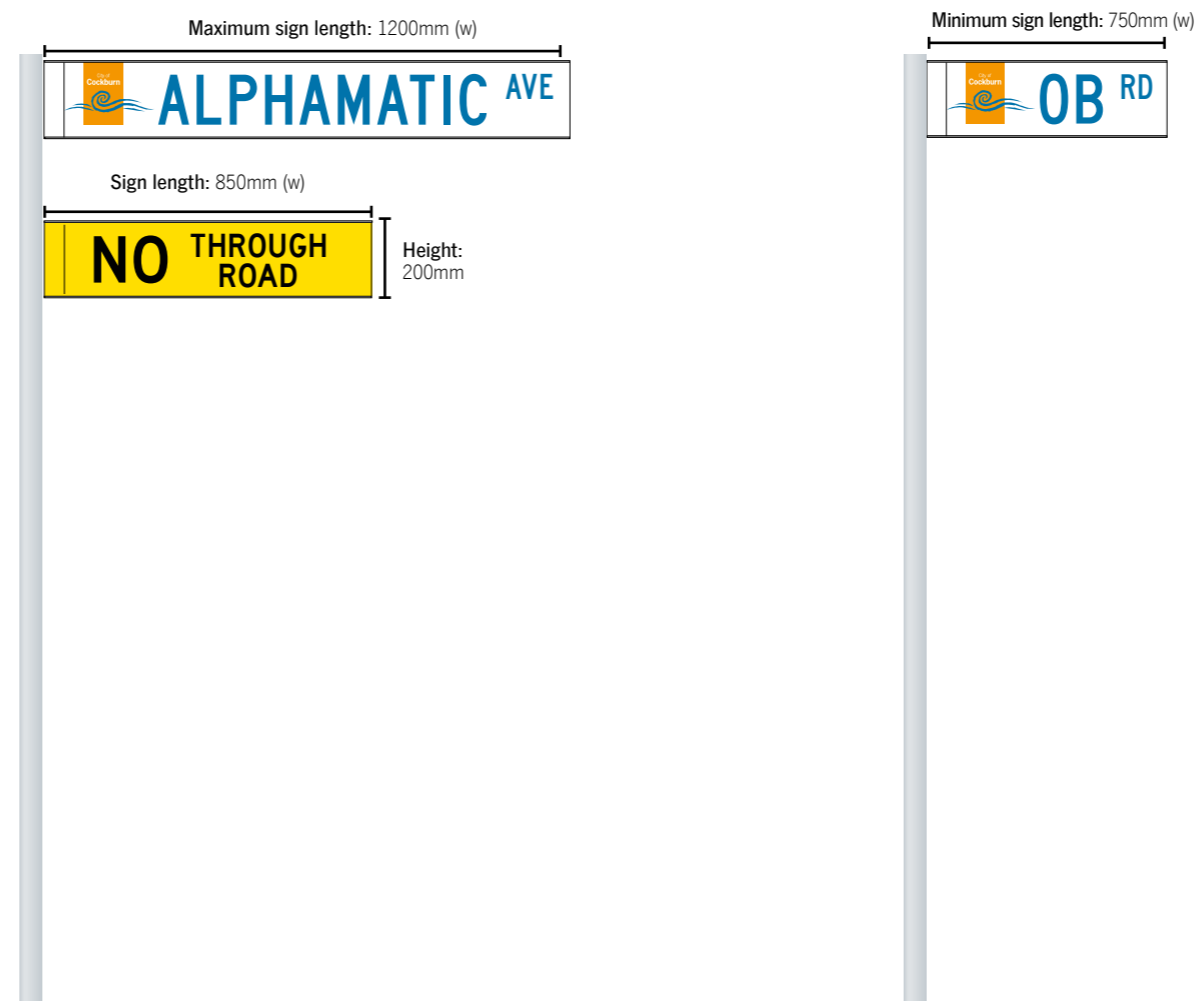
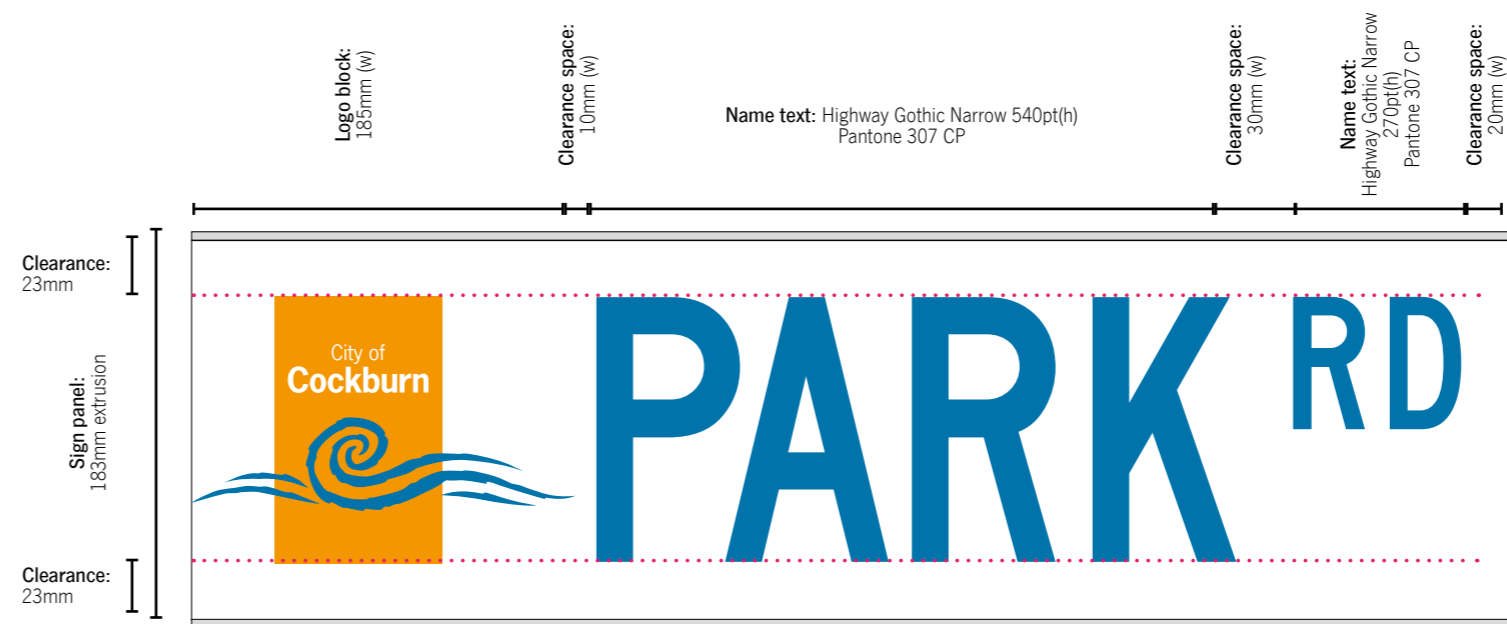

5.2 Fingerboard street name signs with poppy

Usage

The poppy symbol is to be added to street fingerboard signs within the district where the streets have been named after a local person, family or other related war or peace keeping activity or commemorative event.

Layout

The following apply to fingerboard signs:

- Each individual sign is to incorporate the service and/or tourist feature/s, represented by a standard symbol where available, or standard text if necessary, and the directions to proceed.
- The use of Australian Standard service and tourist symbols is limited to five symbols per sign.
- In any one sign stack the maximum number of fingerboards is four, inclusive of the road name sign.
- Tourist and service signs shall have upper case lettering only using the Australian Standard (AS) 1744 Series standard font.
- For more information refer to Australian Standards.

Dimensions

Text: Refer to Australian Standard - Standard Alphabets for Road Signage AS 1744-1975 for details.

Sign face: Maximum length of 1500mm and height of 300mm. Each sign in a signage stack is to be 900mm, 1200mm or 1500mm in length, as determined by the text and or symbol on the sign.

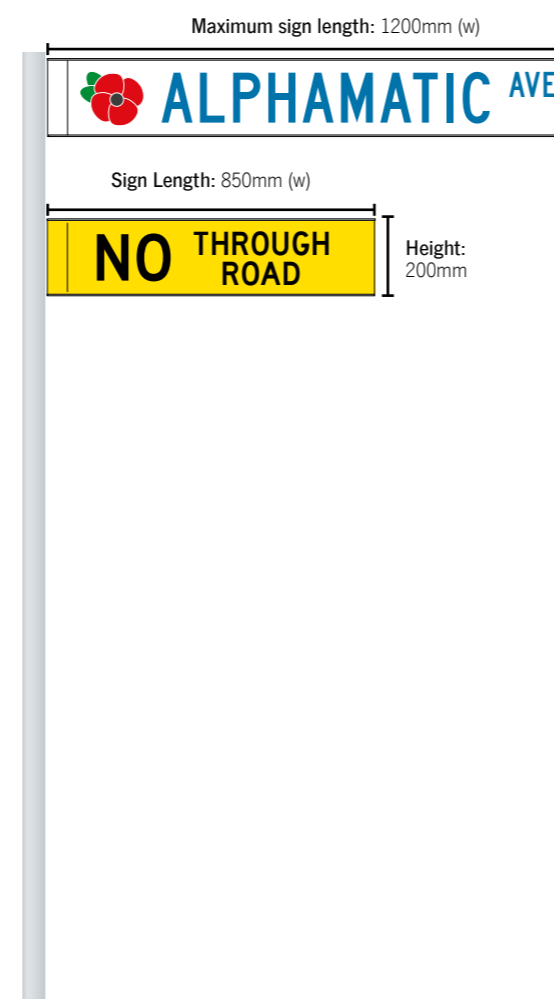
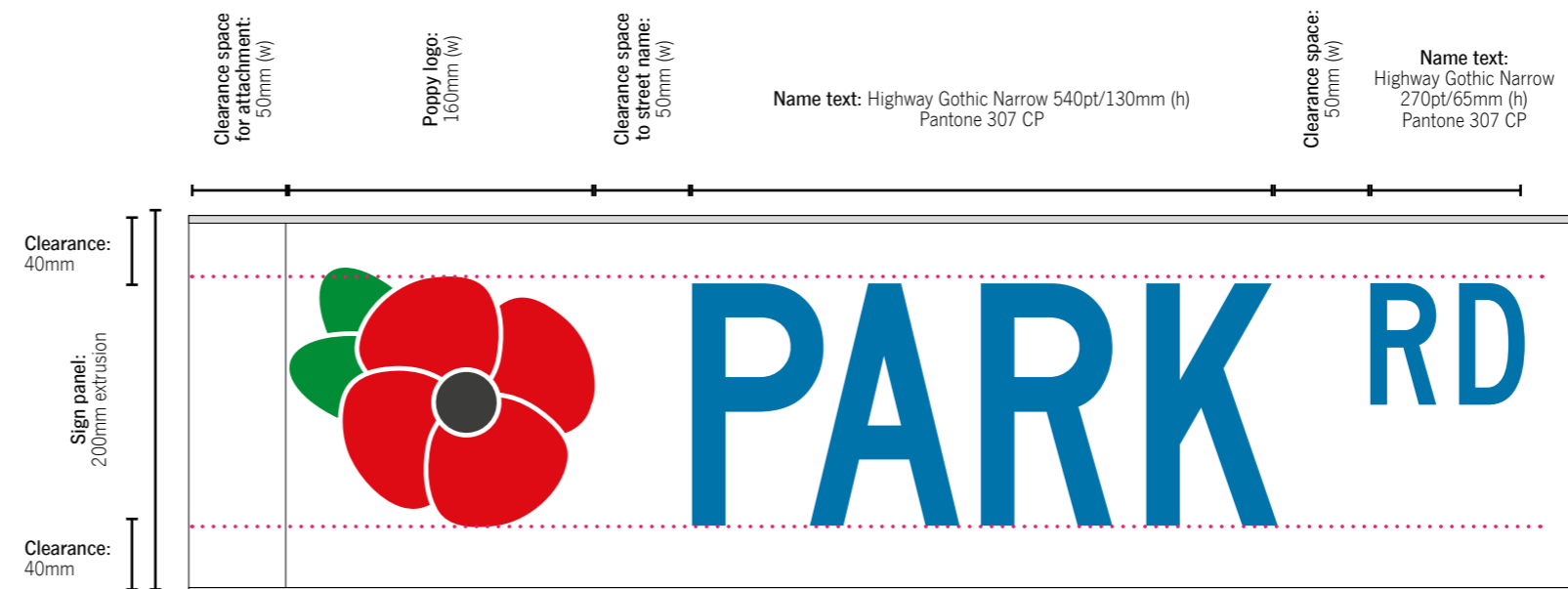

5.3 Community facility name signs

Usage

Refer to Engineering Services' Community Facility Name Sign guidelines for approval requirements.

Layout

The following apply to fingerboard signs:

- Each individual sign is to incorporate the service and/or tourist feature/s, represented by a standard symbol where available, or standard text if necessary, and the directions to proceed.
- The use of Australian Standard service and tourist symbols is limited to five symbols per sign.
- In any one sign stack the maximum number of fingerboards is four, inclusive of the road name sign.
- Tourist and service signs shall have upper case lettering only using the Australian Standard (AS) 1744 Series standard font.
- For more information refer to Australian Standards.

Dimensions

Text: Refer to Australian Standard - Standard Alphabets for Road Signage AS 1744-1975 for details.

Sign face: Maximum length of 1500mm and height of 300mm.

Each sign in a signage stack is to be 900mm, 1200mm or 1500mm in length, as determined by the text and or symbol on the sign.

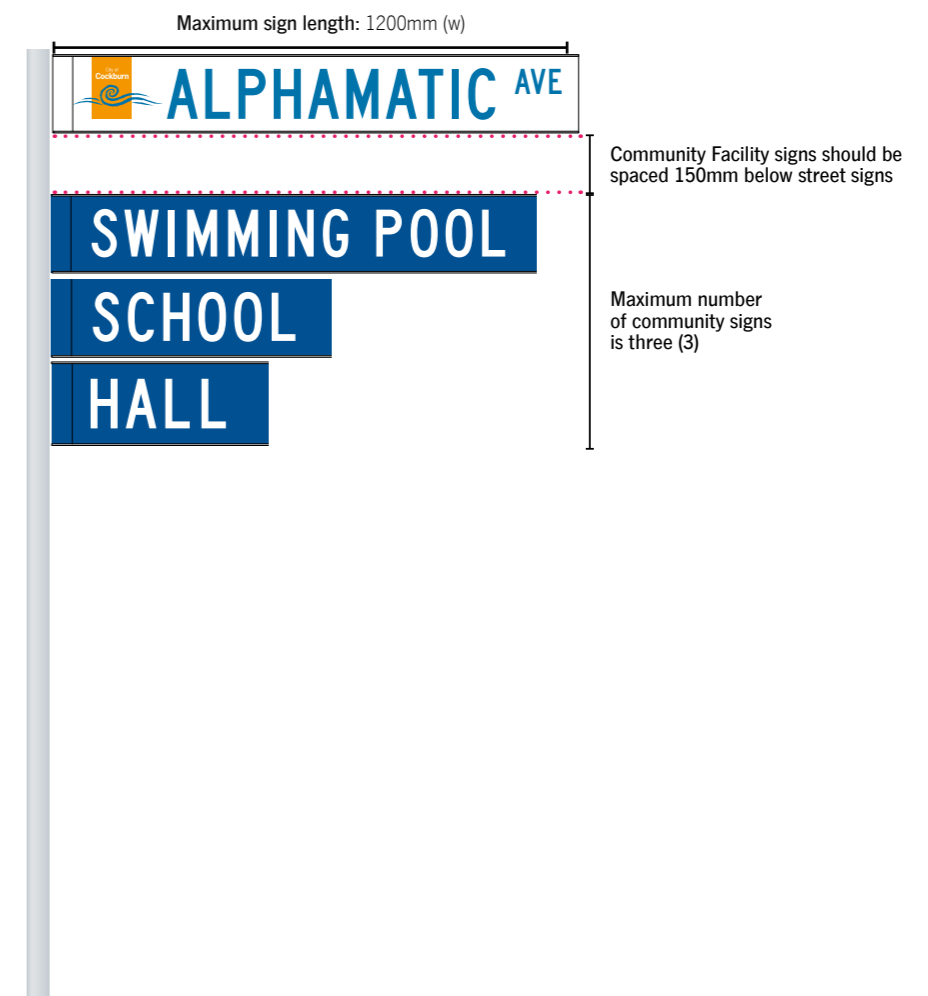
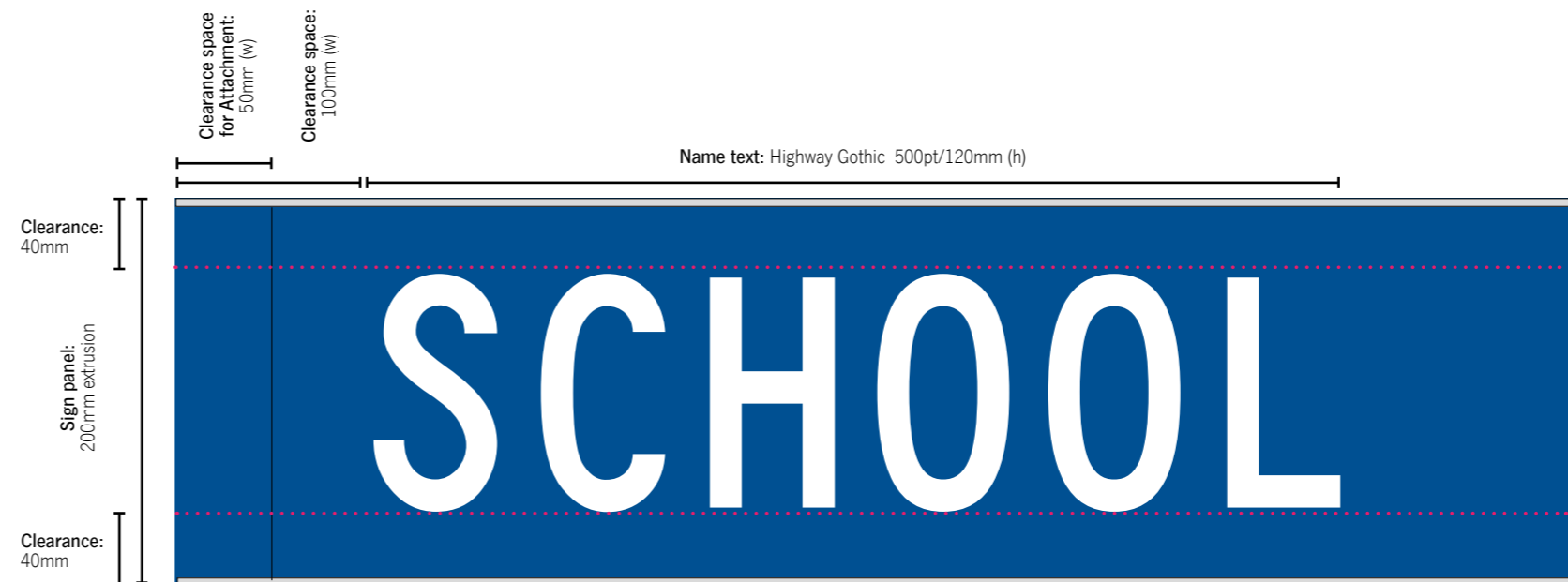

5.4 Facility directional sign proportions

The examples demonstrates the proportion of a typical panel sign. Whilst most panel signs are designed usually the three standard sizes (Section 3.4).

When a custom sized sign is required by using the sign ratios on this page any custom size can be created to fit within the City of Cockburn signage system.

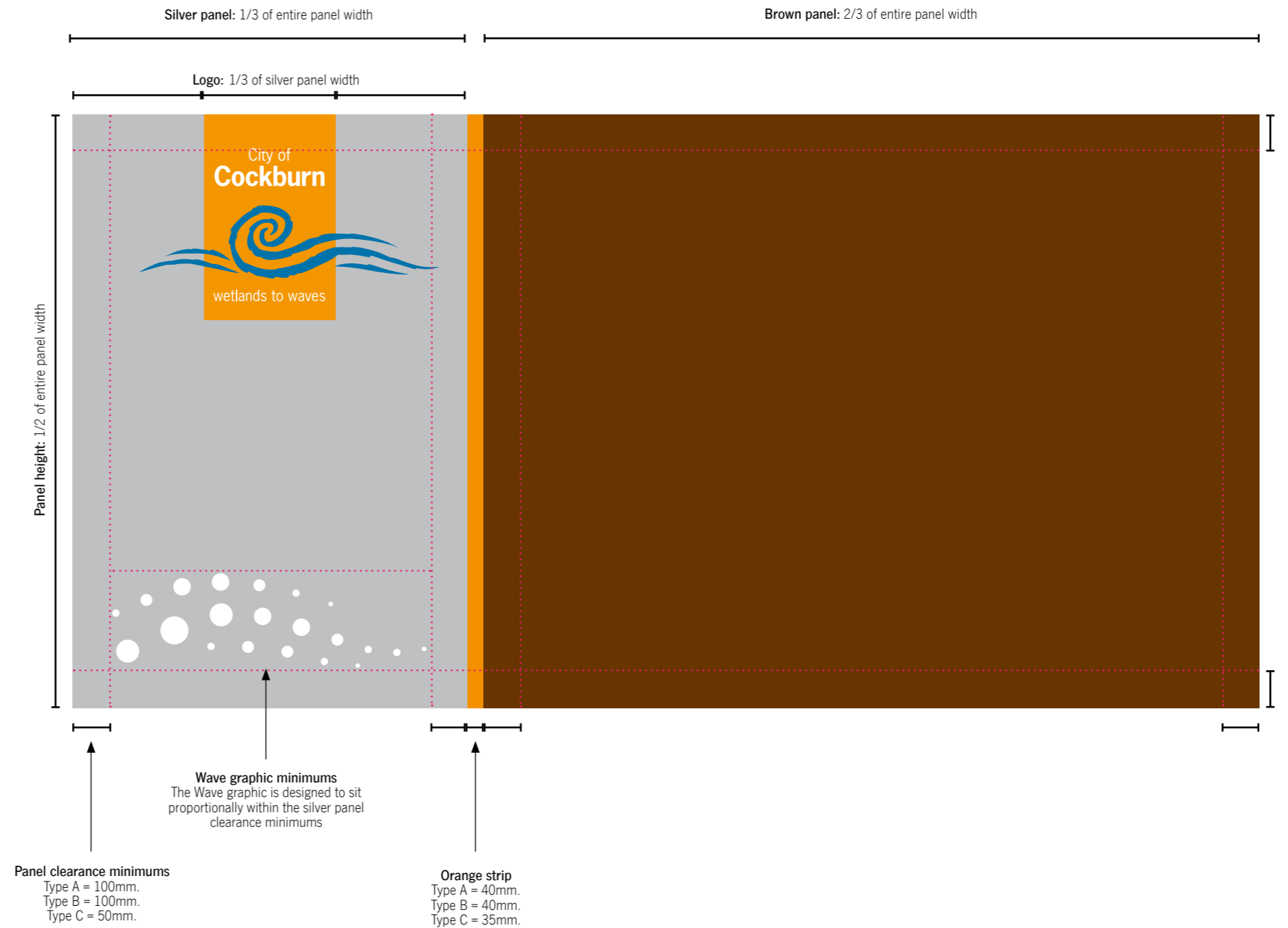

5.4 Facility directional sign types

These signs are used across numerous applications throughout the City of Cockburn include vehicle and pedestrian wayfinding and facility signage.

Each sign may includes:

- City of Cockburn colour palette
- City of Cockburn logo
- Name of destination (wayfinding)
- Name of facility (destination)
- Address of facility
- Directional arrows
- Australian standard symbols
- Supporting Wave graphic

Dimensions

Type A: 3000mm (w) x 1500mm (h)

Type B: 2400mm (w) x 1200mm (h)

Type C: 1500mm (w) x 750mm (h)

Type A - 3000mm (w) x 1500mm (h)

Example location: City Administration



Type A panel signs

These signs are generally used at primary entrances to City of Cockburn facilities that have numerous services clustered in the same location and require the listing and wayfinding to these services. Example of where these signs are used include the City of Cockburn Administration Centre and the Cockburn Central Library building. Type A panel signs can be used as vehicle wayfinding or as facility signs.

Type B - 2400mm (w) x 1200mm (h)

Example location: Anning Park



Type B panel signs

These signs are generally used at secondary entrances to City of Cockburn facilities that have numerous services clustered in the same location and require the listing and wayfinding to these services. Example of where these signs are used include the City of Cockburn Administration Centre and the Cockburn Central Library building. Type B panel signs can be used as vehicle wayfinding or as medium sized facility signs.

Type C - 1500mm (w) x 750mm (h)

Example location: Jean Willis Centre



Type C panel signs

These signs are generally used at pedestrian and tertiary entrances to City of Cockburn facilities that have numerous services clustered in the same location and require the listing and wayfinding to these services. Example of where these signs are used include the City of Cockburn Administration Centre and the Cockburn Central Library building. Type C panel signs can be used as pedestrian wayfinding or as small facility signs.

5.5 Facility directional sign typeface sizes

This City of Cockburn standard panel signs use the city's standard typeface for all city signage. This typeface will vary in size dependant on the size of the sign. Refer to the three standard sign sizes when choosing the correct sized typeface for your sign.

Address information

Signage can include address details. Check with Strategic Planning Services on the correct site address prior to fabrication.

Type A - 3000mm (w) x 1500mm (h)



Type B - 2400mm (w) x 1200mm (h)



Type C - 1500mm (w) x 750mm (h)



5.6 Facility pedestrian wayfinding sign A

These signs are used at decision points at facilities and buildings to assist pedestrians to find their way to their destination or a particular location.

- Each sign includes:
- City of Cockburn colour palette
- Name of facility (destination)
- Directional arrows
- Standard symbols

Dimensions

350mm (w) x 1300mm (h)

Facility pedestrian wayfinding sign A

These signs are generally used at pedestrian and tertiary entrances to City of Cockburn facilities that have key services listed and wayfinding to these services. Example of where these signs are used include the City of Cockburn Administration Centre and the Cockburn Central Library building.

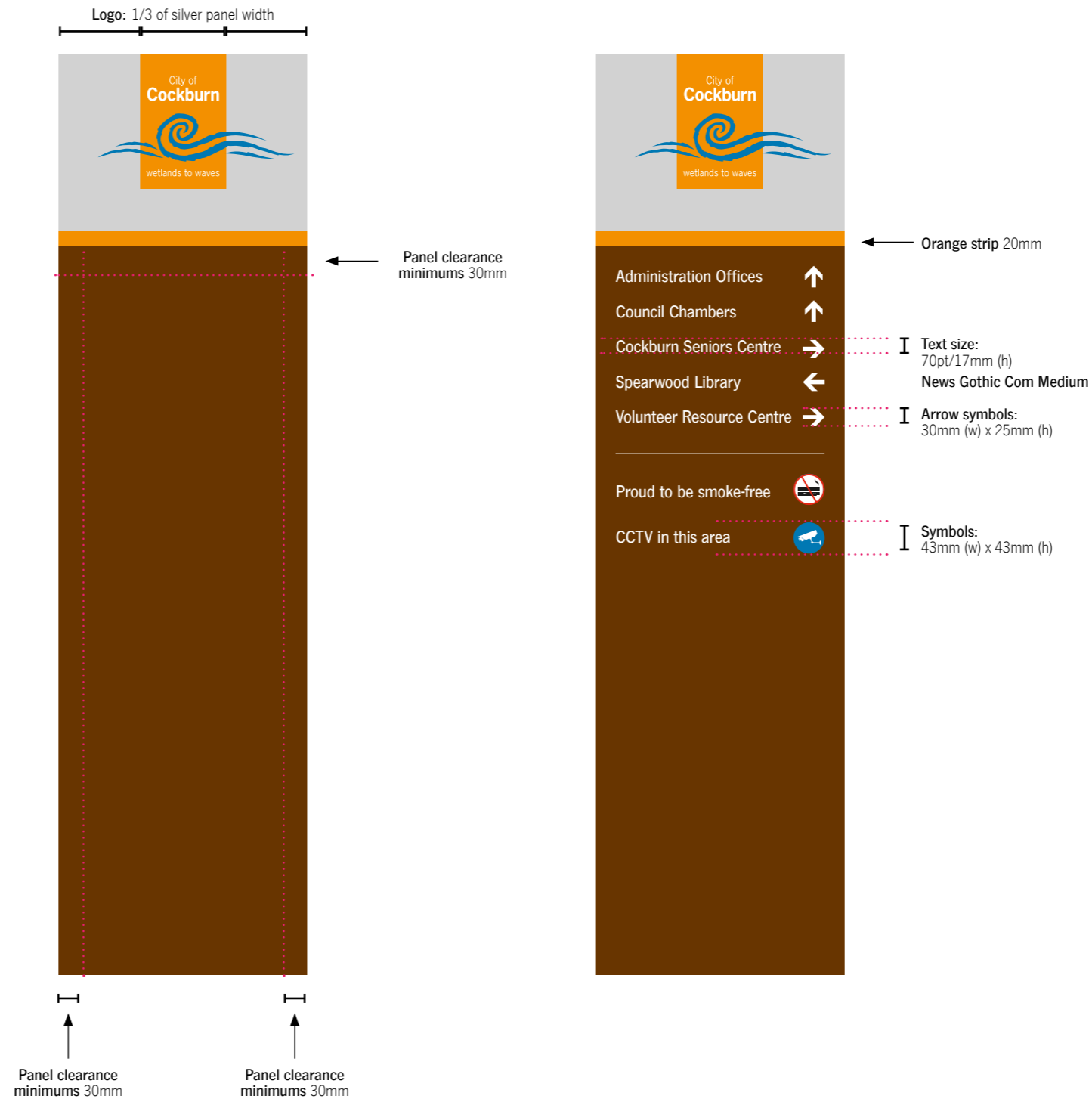

5.7 Facility pedestrian wayfinding sign B

These signs are used at decision points at facilities and buildings to assist pedestrians to find their way to their destination or a particular location.

Each sign includes:

- City of Cockburn colour palette
- City of Cockburn logo
- Name of destination (wayfinding)
- Name of facilities (destination)
- Directional arrows
- Supporting Wave graphic

Dimensions

1100mm (w) x 2400mm (h)

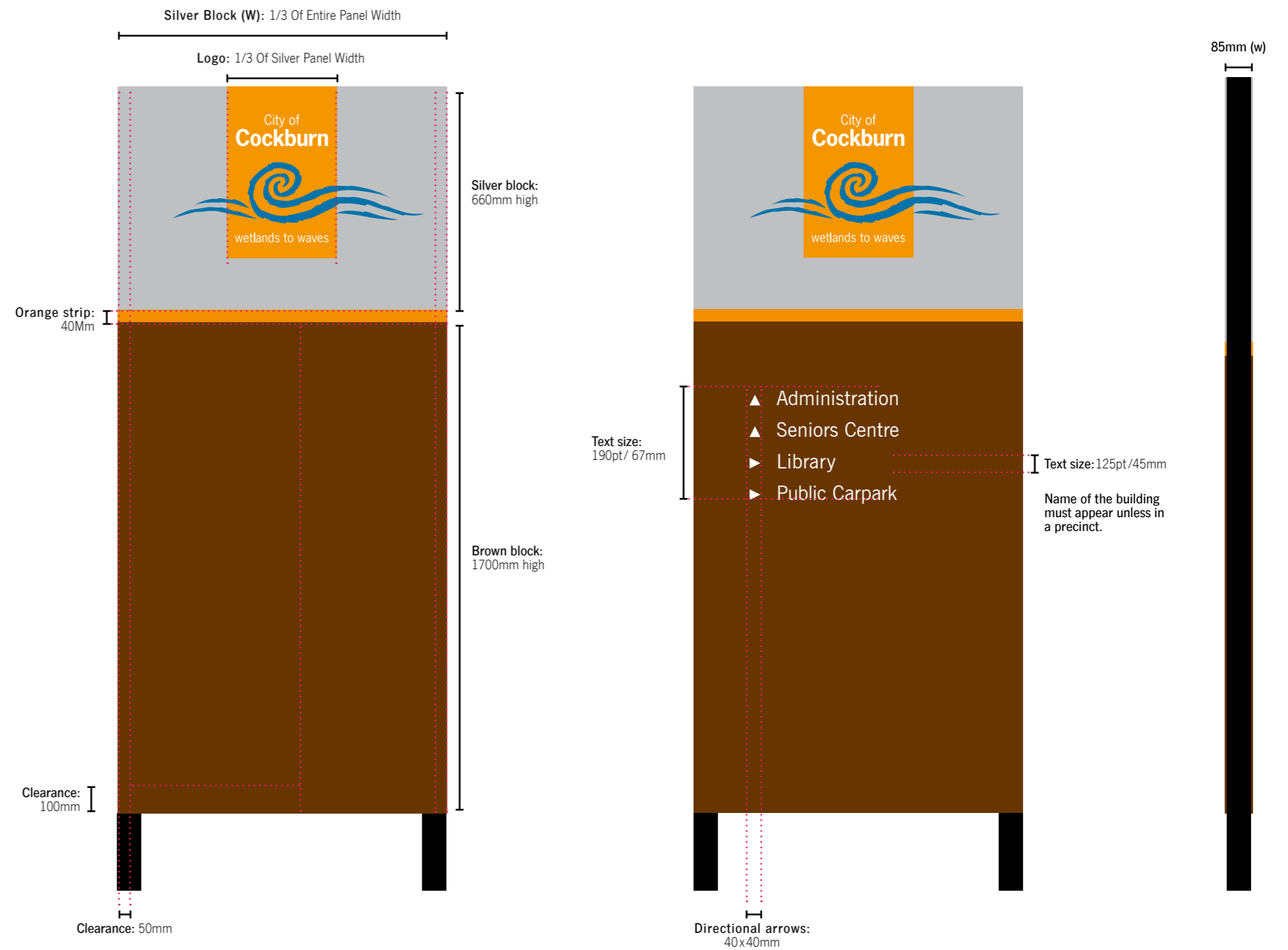

Side view

5.8 Facility pedestrian wayfinding sign C multiple locations

These signs are used at points of interest within the park or reserve. Specific locations within the park will have these signs to give you a history of the location or provide you with a heritage trail.

Each sign includes:

- City of Cockburn colour palette
- City of Cockburn logo
- Park or reserve name
- Image (heritage trail, map)

Dimensions

350mm (w) x 1800mm (h)

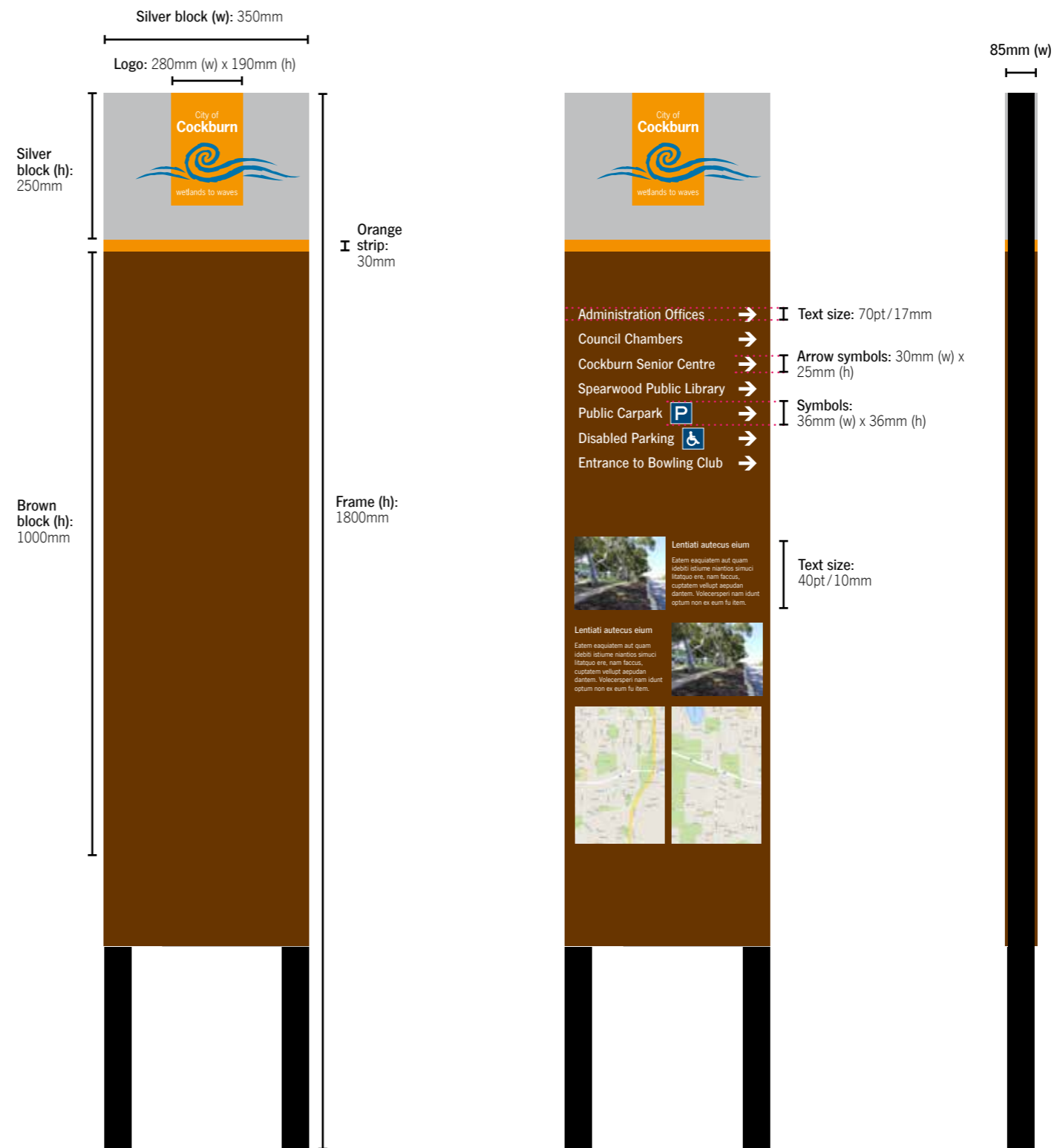

6.0 Facility and building signs



Structure for facility and building signs

Below is a list and sizes of all the **facility and building** signs for the City of Cockburn.

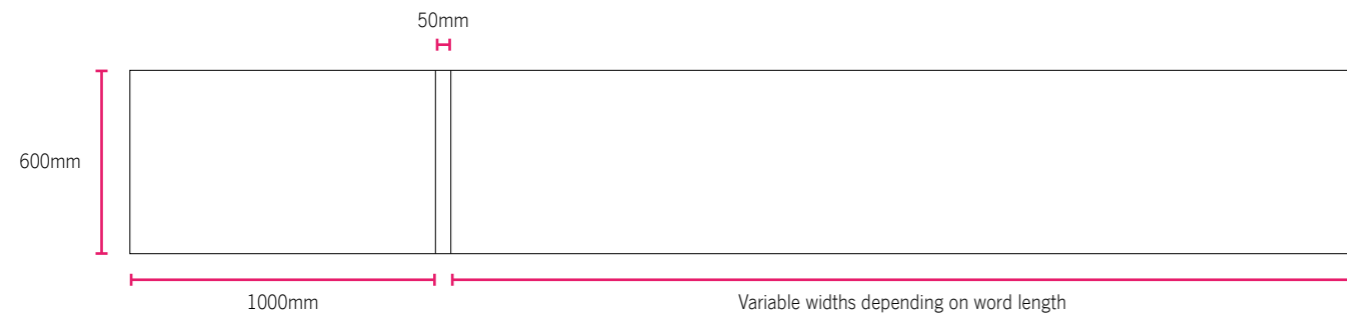

Facility building sign A

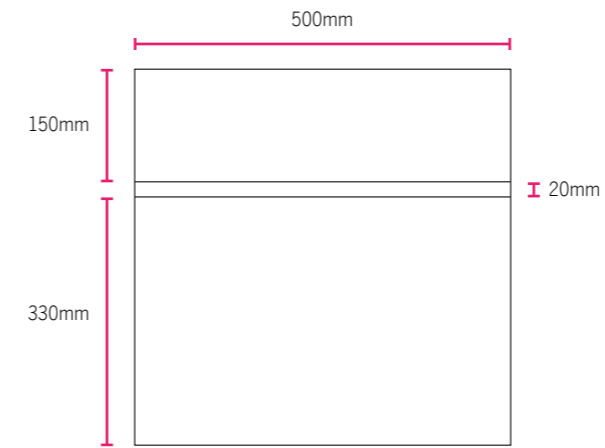

Secondary facility entry sign

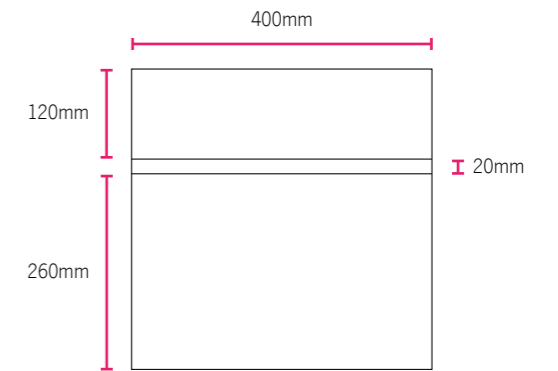

Information entry sign

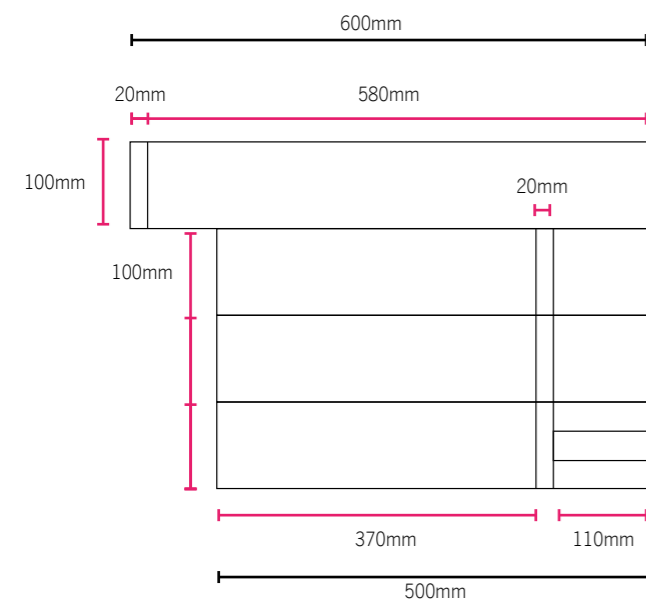

Internal/external wayfinding A

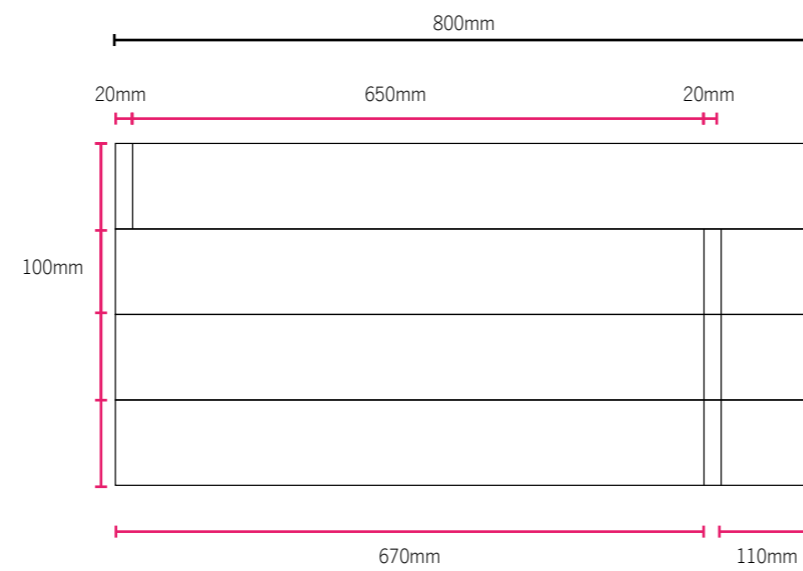

Internal/external wayfinding B

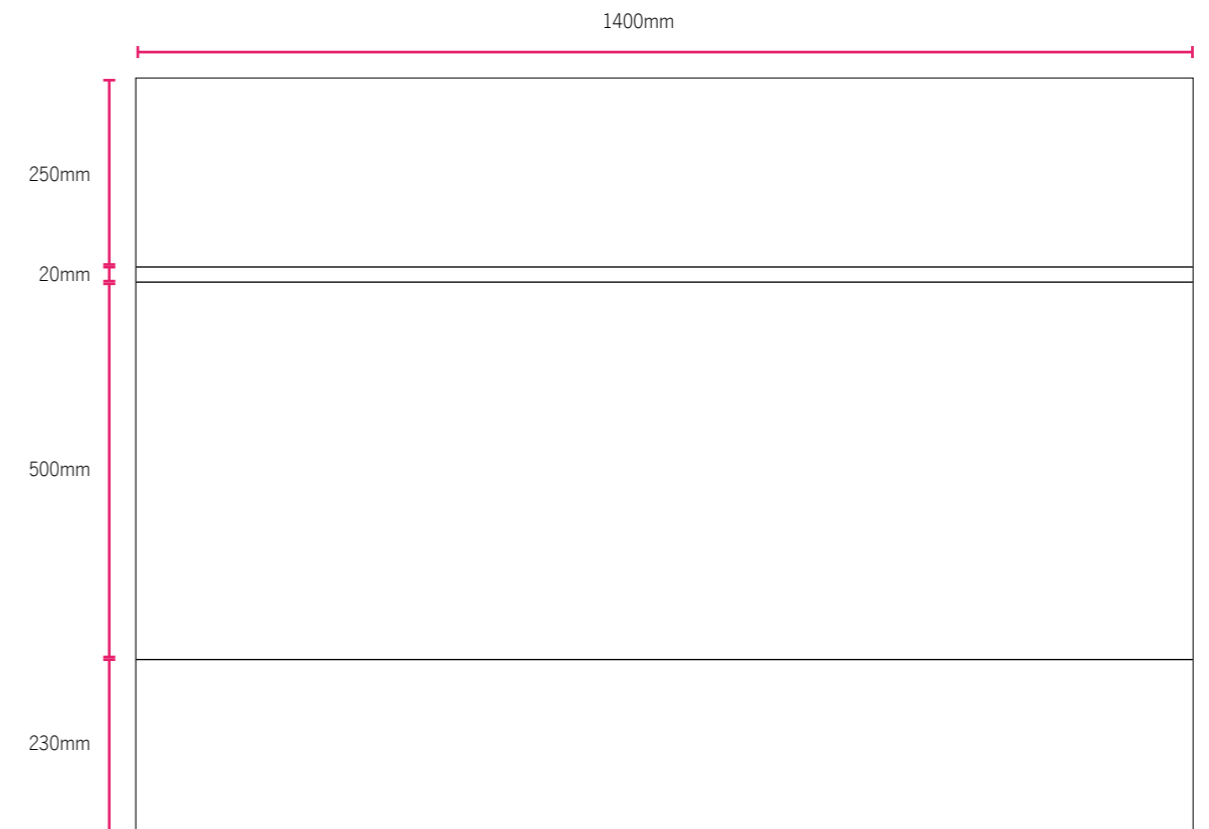

Water Parks Sign

6.1 Facility building sign A

These signs are used at entrances of facilities and buildings to assist pedestrians to find their destination or location.

Each sign includes:

- City of Cockburn colour palette
- City of Cockburn logo
- Name of facility or building (wayfinding)

Dimensions

(w) dependent on word/name x 600mm (h)

Address information

Signage can include address details. Check with Strategic Planning Services on the correct site address prior to fabrication.



Font = News Gothic Com Medium

6.2 Secondary facility entry sign

These signs are used at eye view entrances of facilities and buildings to assist pedestrians to clearly identify their destination or location.

Each sign includes:

- City of Cockburn colour palette
- City of Cockburn logo
- Name of facility or building (wayfinding)

Dimensions

510mm (w) x 510mm (h)

Address information

Signage can include address details. Check with Strategic Planning Services on the correct site address prior to fabrication.

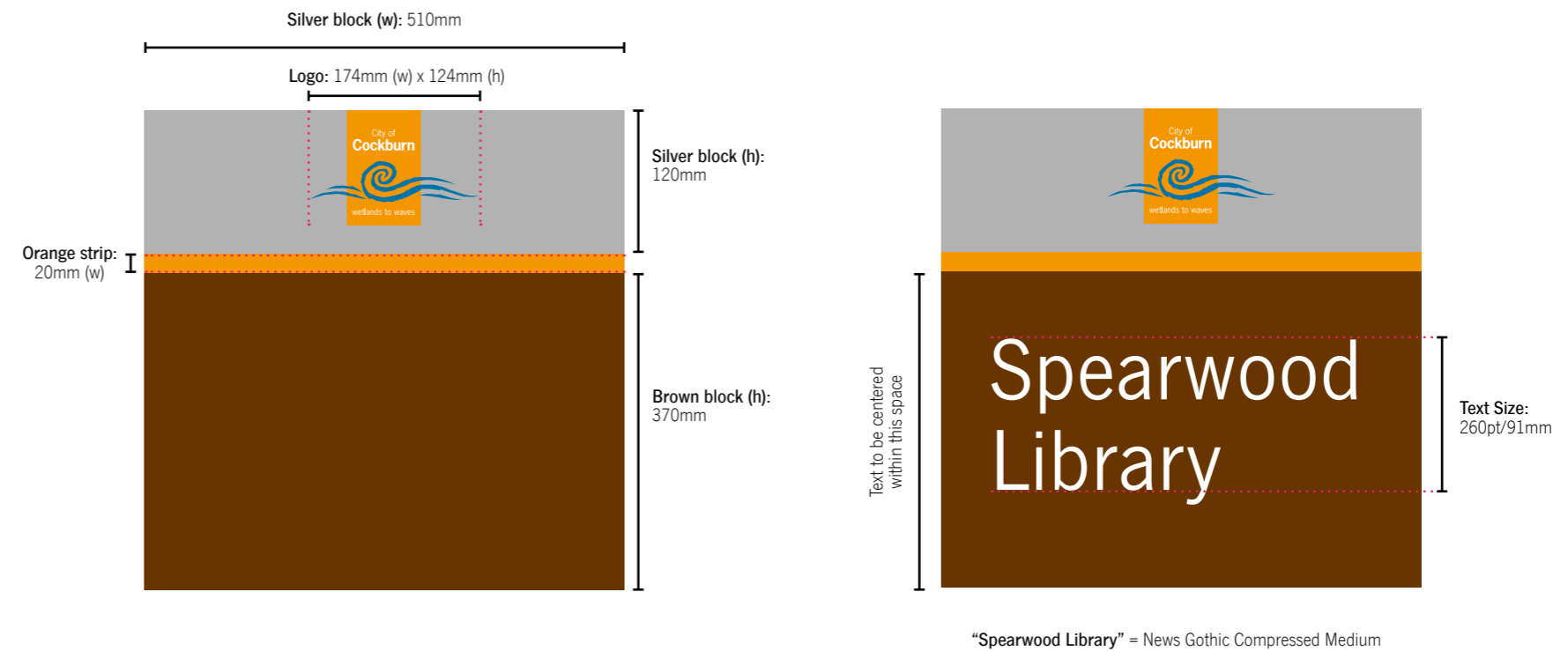

6.3 Information entry sign

These signs are used at eye view entrances of facilities and buildings. They will have information detailing the building or facilities address, contact information and opening times.

Each sign includes:

City of Cockburn colour palette

- City of Cockburn logo
- Detailed information

Dimensions

400mm (w) x 400mm (h)

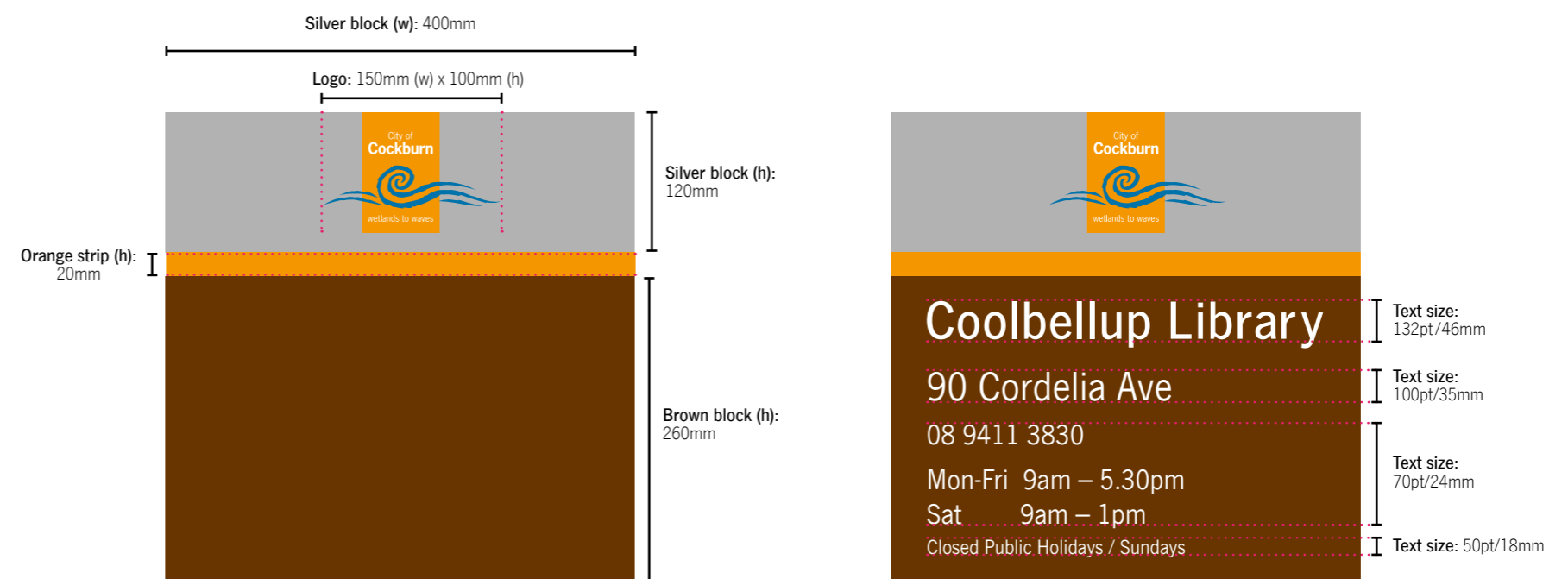

“Coolbellup Library” = News Gothic Compressed Medium

“90 Cordelia Ave” = News Gothic Compressed Roman

“Number, times, public holidays” = News Gothic Compressed Light

6.4 Internal/external wayfinding signs type A and B

These signs are used within facilities and buildings to assist people with finding their destination.

Each sign includes:

- City of Cockburn colour palette
- Facility, building or room names
- Directional arrows

Note: Same signage system to be used for external building wayfinding.

Dimensions

(w) dependent on word/name x 400mm (h)

Internal/external wayfinding type A

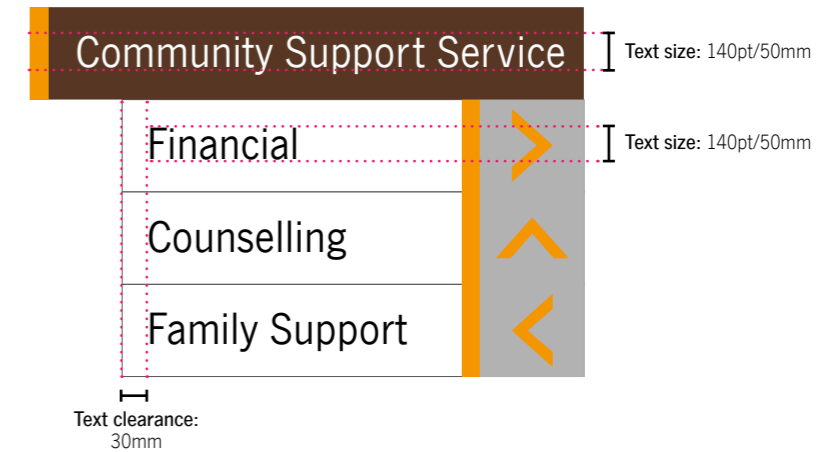
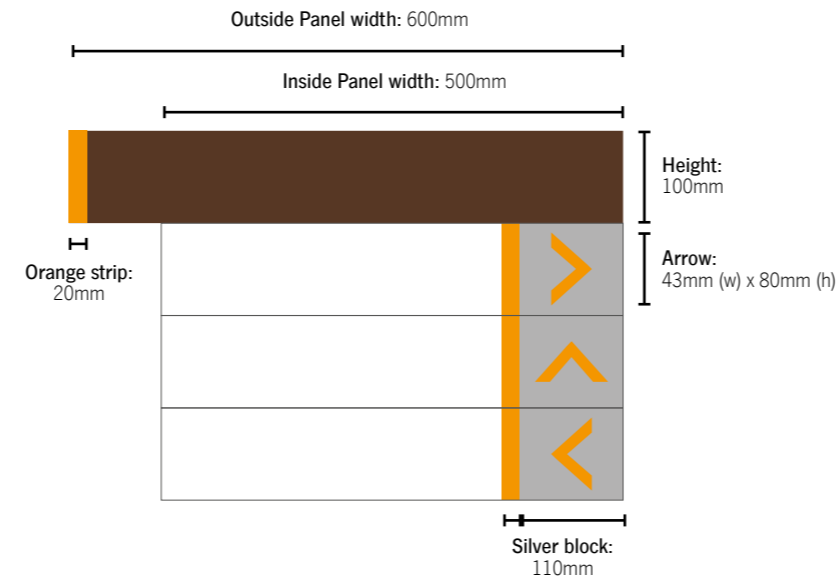

“Community Support Service” = News Gothic Compressed Roman
 “Financial, Counselling, Family Support” = News Gothic Compressed Roman

Internal/external wayfinding type B

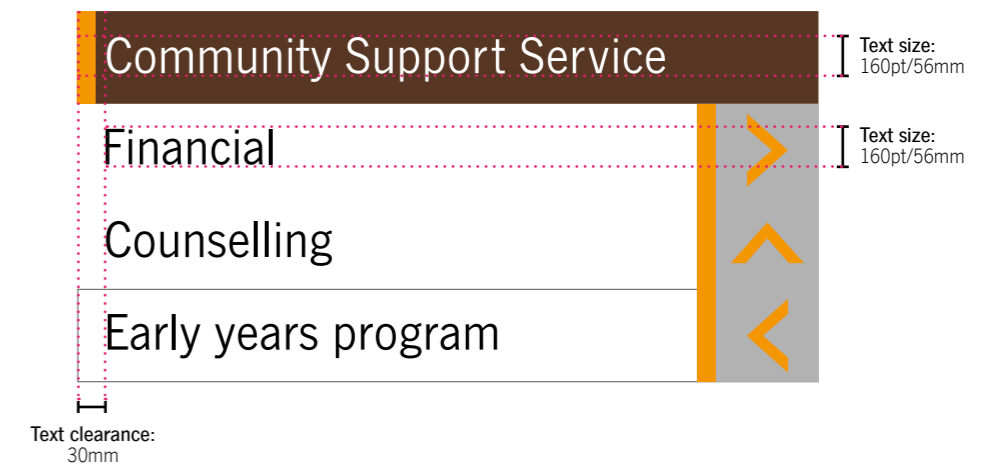
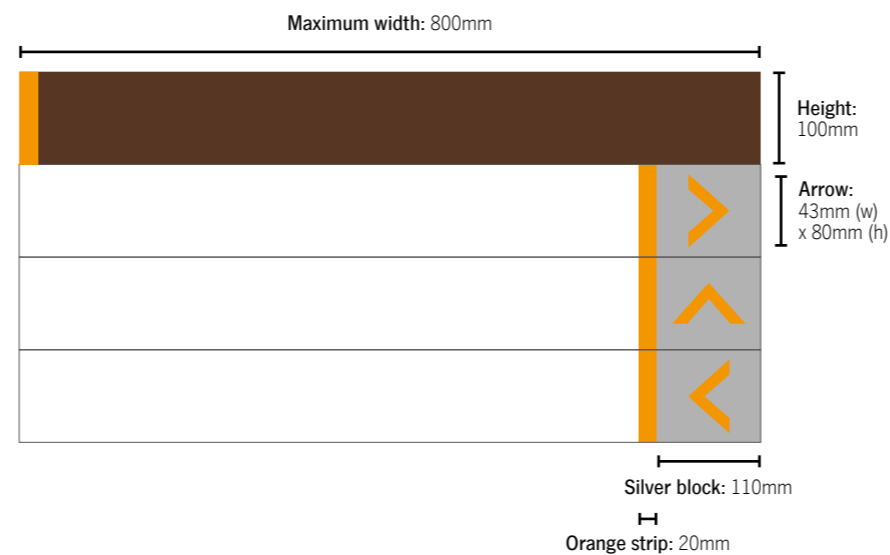

“Community Support Service” = News Gothic Compressed Roman
 “Financial, Counseling, Early years program” = News Gothic Compressed Roman

6.4 Internal/external wayfinding signs type C

These signs are used within facilities and buildings to assist people with finding their destination.

Each sign includes:

- City of Cockburn colour palette
- Facility, building or room names
- Directional arrows

Note: Same signage system to be used for external building wayfinding.

Dimensions

(w) dependent on word/name x 100mm (h)

Internal/external wayfinding type C

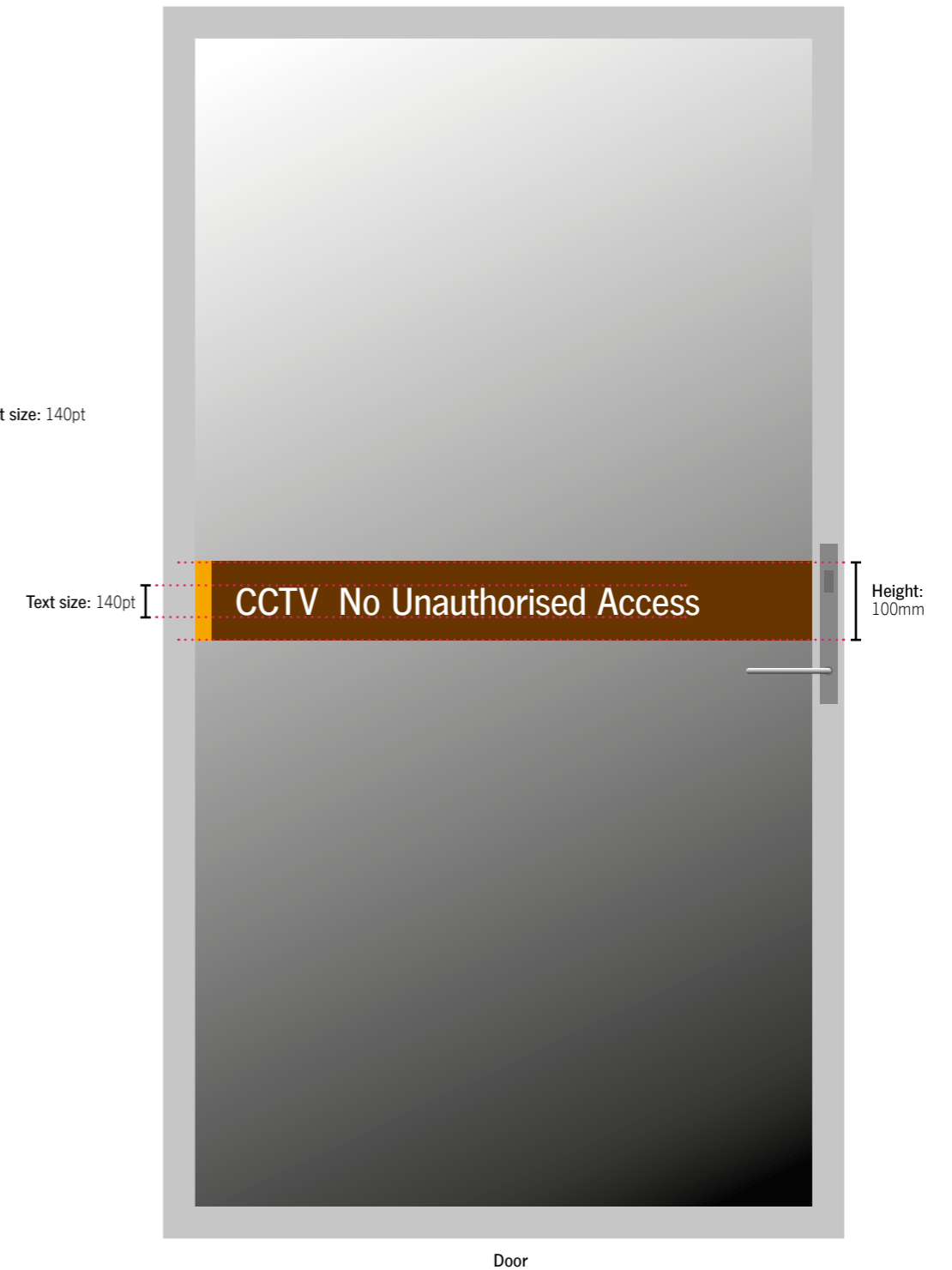
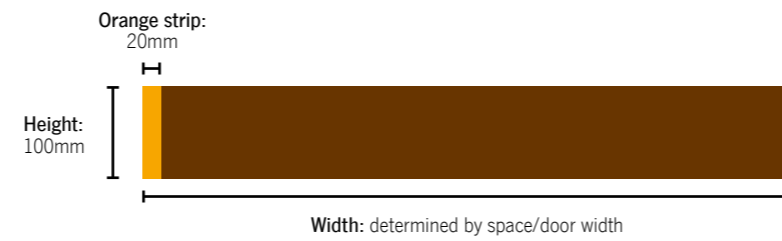

6.4 Internal/external wayfinding signs type D title and name

These signs are used within facilities and buildings to assist people with finding their destination.

Each sign includes:

- City of Cockburn colour palette
- Facility, building or room names
- Directional arrows

Note: Same signage system to be used for external building wayfinding.

Dimensions

(w) dependent on door width x 100mm (h)

Internal / external wayfinding type D title and name

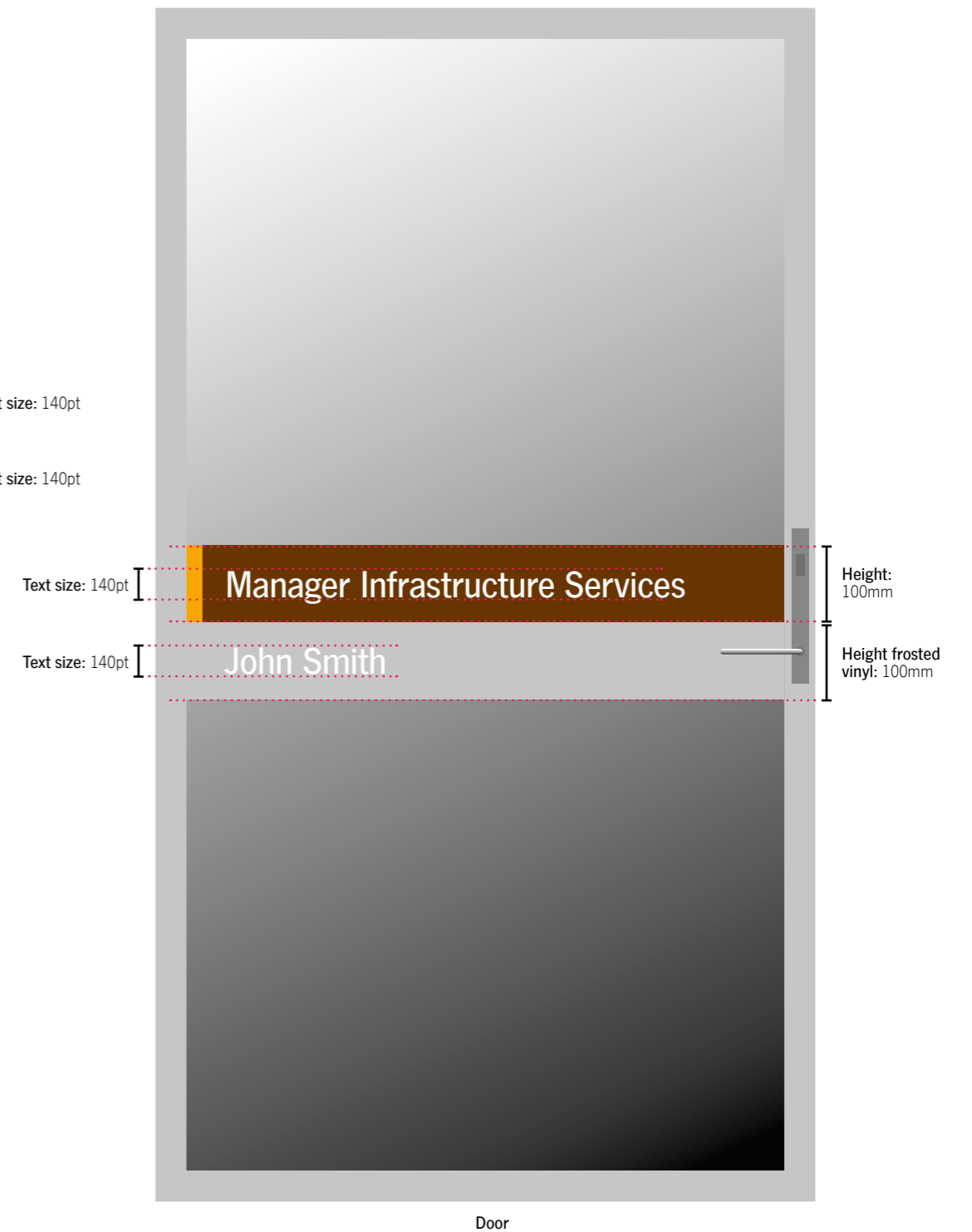
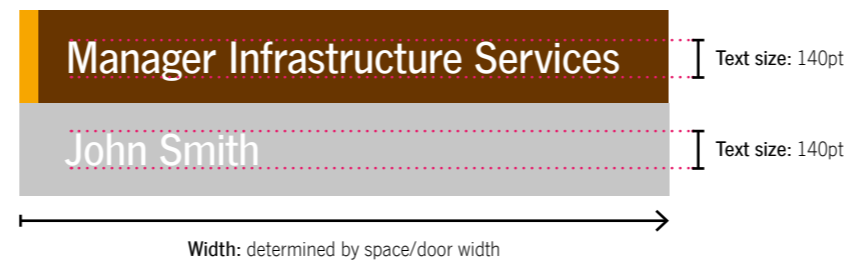

6.5 Water parks

These signs are used as a warning and rules when entering a water park of the City of Cockburn.

Each sign will feature Australian standard icons and warnings which should be followed at all times when in the waterpark.

Each sign includes:

- City of Cockburn colour palette
- City of Cockburn logo
- Rules and regulations of waterpark
- Australian standards icons

Dimensions

1400mm (w) x 1000mm (h)

Address information

Signage can include address details. Check with Strategic Planning Services on the correct site address prior to fabrication.

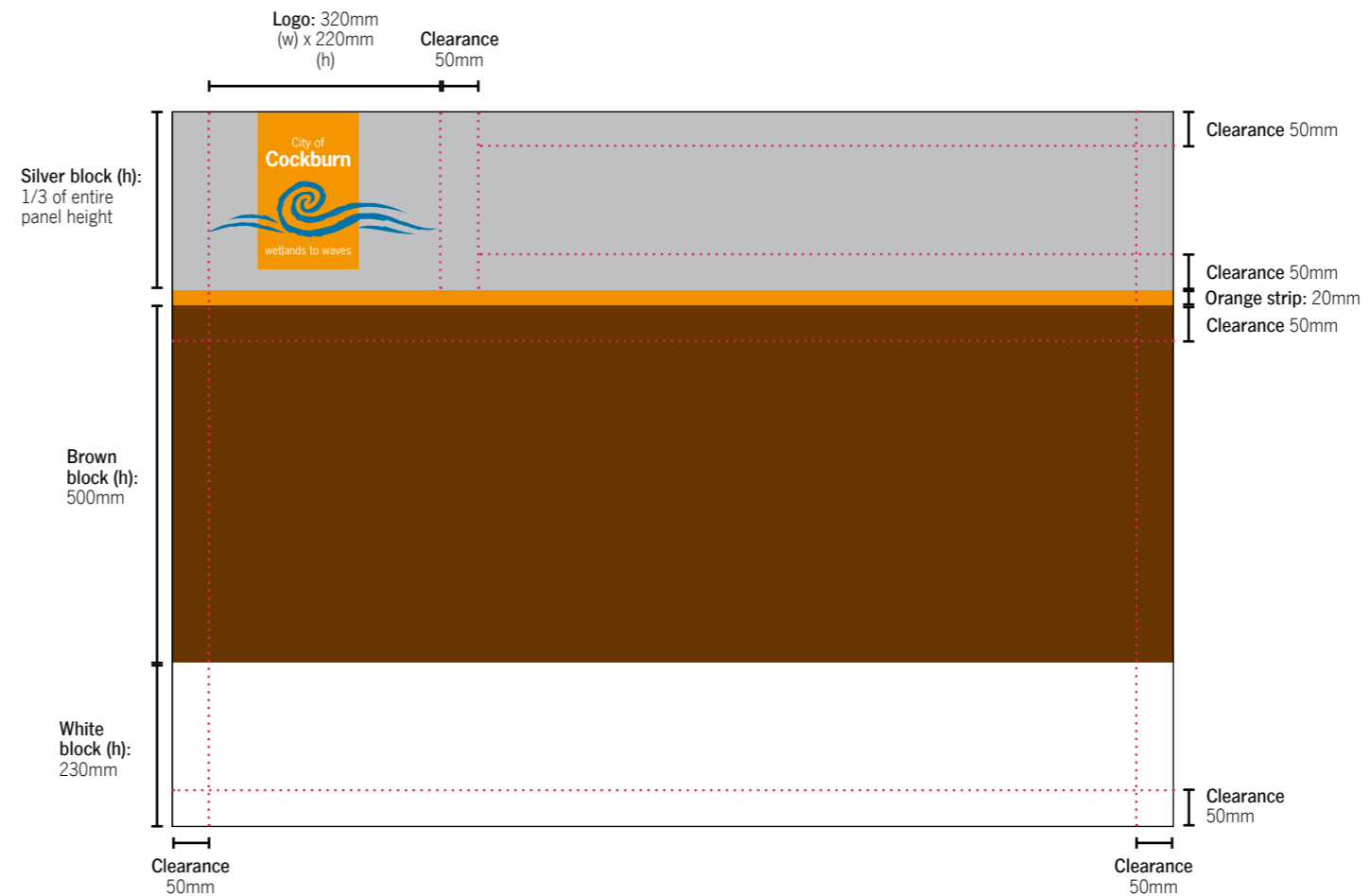

6.6 Facility and other plaques

These plaques are used to signify the official opening of a facility or service by the City of Cockburn. They may also be used for commemorative or other appropriate uses.

The wording opposite is pre-approved by the Mayor for openings but the final artwork must be run past the Mayor's PA for the Mayor's approval.

Each plaque should be produced in brass or stainless steel. Artwork should be created in mono to ensure best reproduction.

Each sign includes:

- City of Cockburn logo without tagline (mono)
- Approved wording and title of opening dignity
- Date of opening
- Supporter logos as required.

Dimensions

297mm (w) x 210mm (h)



7.0 Parks and amenity signs



Structure for facility and building signs

Below is a list and sizes of all the facility and building signs for the City of Cockburn.

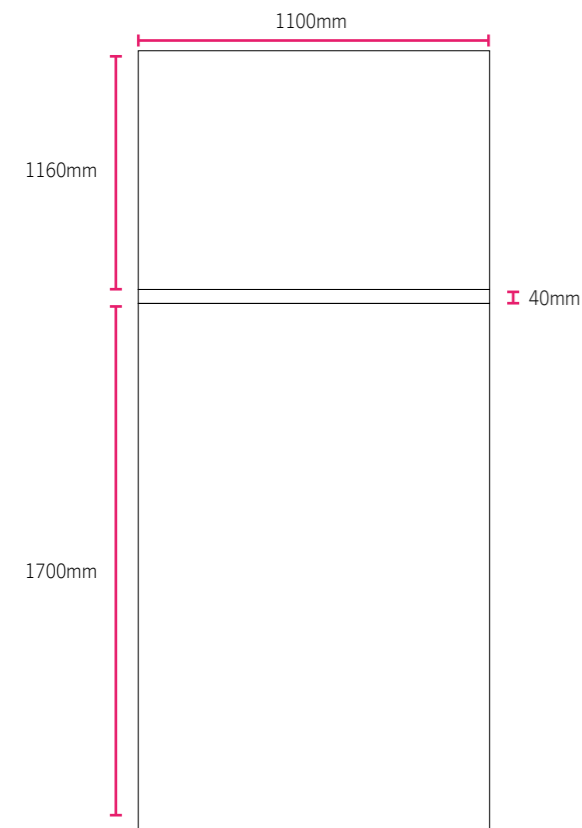

Park entry sign

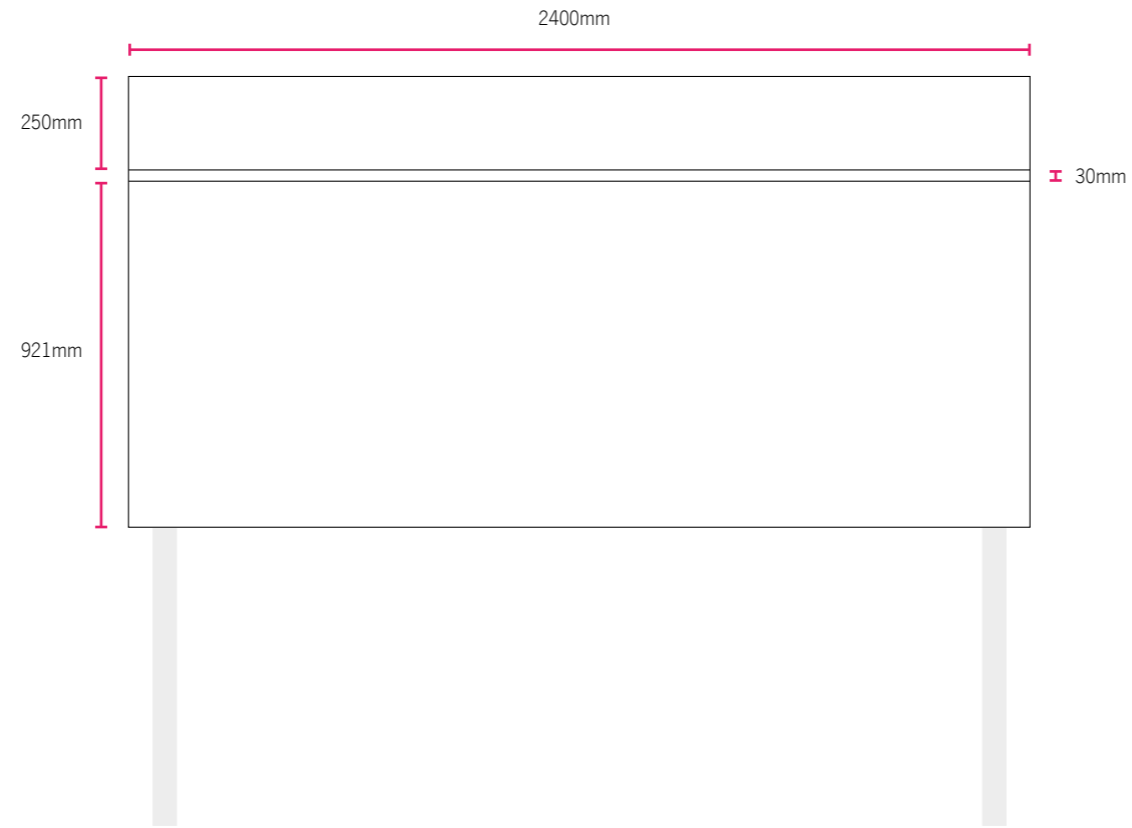

Primary park information sign

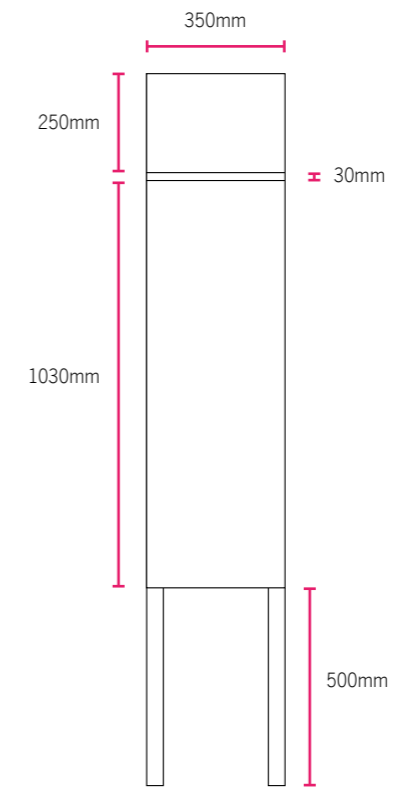

Location park information sign A

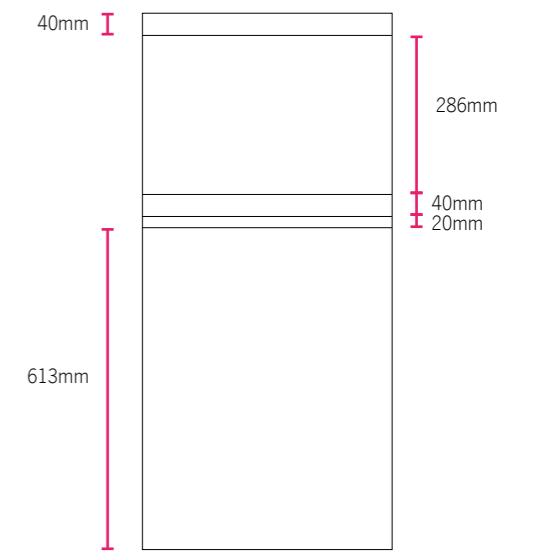

Location park information sign B

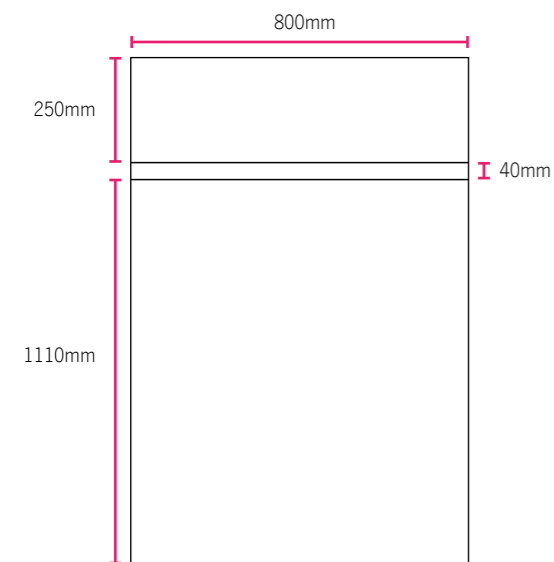

Secondary park entry sign A

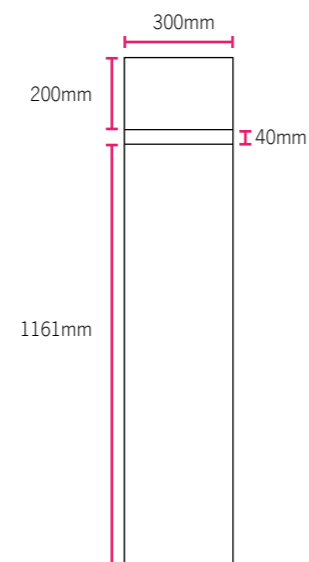

Secondary park entry sign B

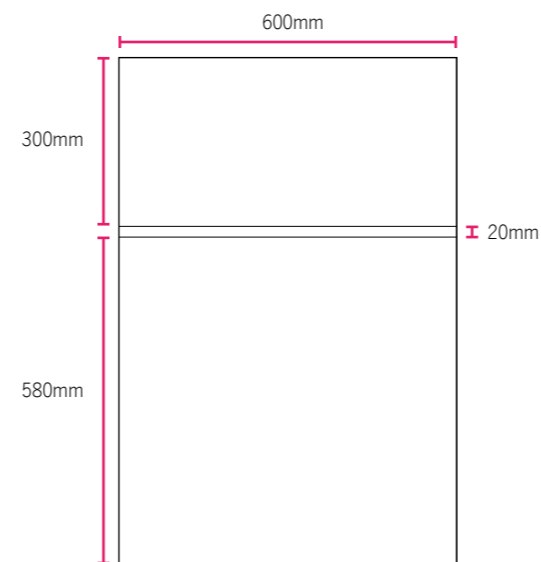

Park event A frame sign

7.1 Primary park entry sign

These signs are used at the entrance to any of the City of Cockburn parks. These signs can be used in either single or double sided applications.

Each sign includes:

- City of Cockburn colour palette
- City of Cockburn logo
- Park name
- Regional Park designated colour and logo
- Welcome message - English and Nyungar

Dog Park Signs

See 11.0 Regulatory signage

Dimensions

1100mm (w) x 2400mm (h)

Address information

Signage can include address details. Check with Strategic Planning Services on the correct site address prior to fabrication.

Aboriginal References

Nyungar - any wording on Nyungar history must be approved by the First Nations Community Development Officer/Manager. At least two weeks notice must be given.

Regional parks

Where signs are installed in a Regional park then the relevant logo should be included in the designated symbol/logo area of the sign. This requirement is relevant to all Parks signs except 7.5, 7.7 and 7.8.

Regional parks sign system



Welcome statements

All park entry/welcome signs are to include the Nyungar welcome word "Wanju".

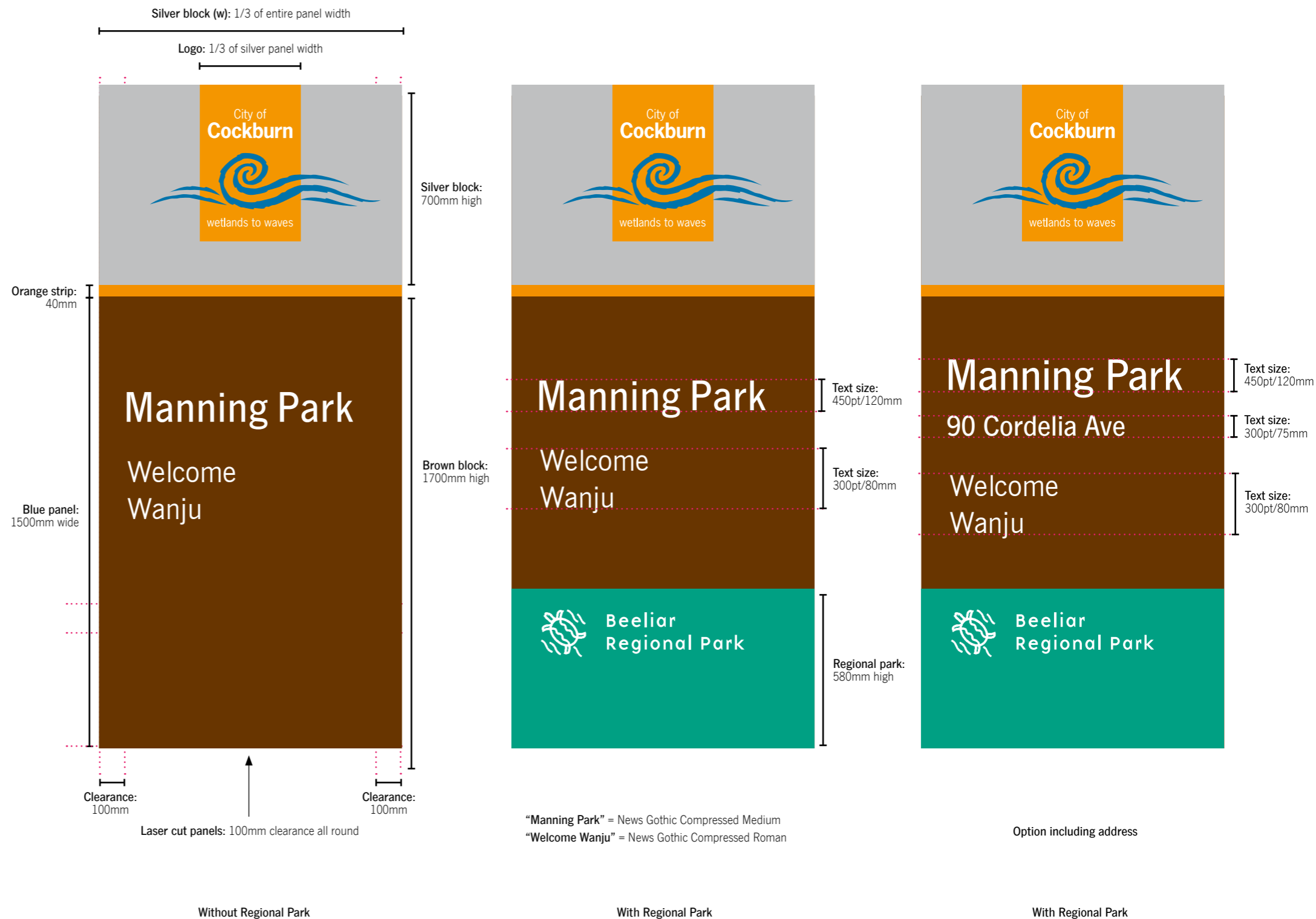

"Manning Park" = News Gothic Compressed Medium
 "Welcome Wanju" = News Gothic Compressed Roman

Option including address

Without Regional Park

With Regional Park

With Regional Park

7.2 Secondary park entry sign A

These signs will be used round City of Cockburn parks. They are there to inform people about what is allowed and not allowed in the park.

Each sign includes:

- City of Cockburn colour palette
- City of Cockburn logo
- Park name
- Regional Park designated colour and logo
- Necessary symbols
- One or two sentences on the origin of the name and another on the Aboriginal history if relevant. The Aboriginal name of the place must be included if it exists.

Dimensions

800mm (w) x 1400mm (h)

Aboriginal references

Nyungar - any wording on Nyungar history must be approved by the First Nations Community Development Officer/Manager. At least two weeks notice must be given.

Regional parks

Where signs are installed in a Regional park then the relevant logo should be included in the designated symbol/logo area of the sign. This requirement is relevant to all Parks signs except 7.5, 7.7 and 7.8..

Regional parks sign system

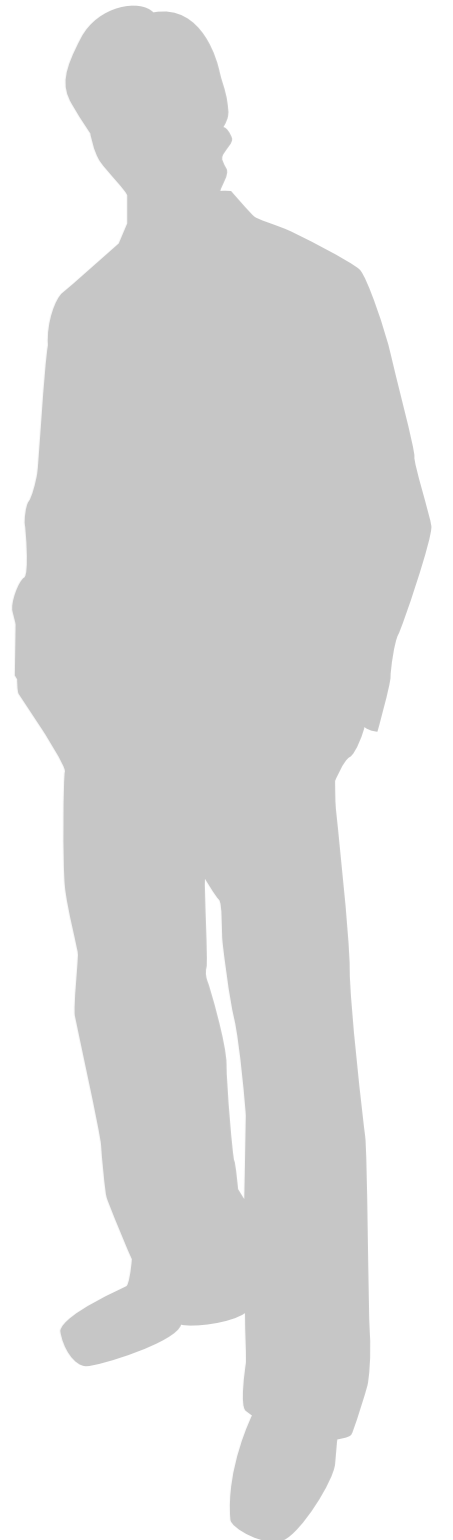
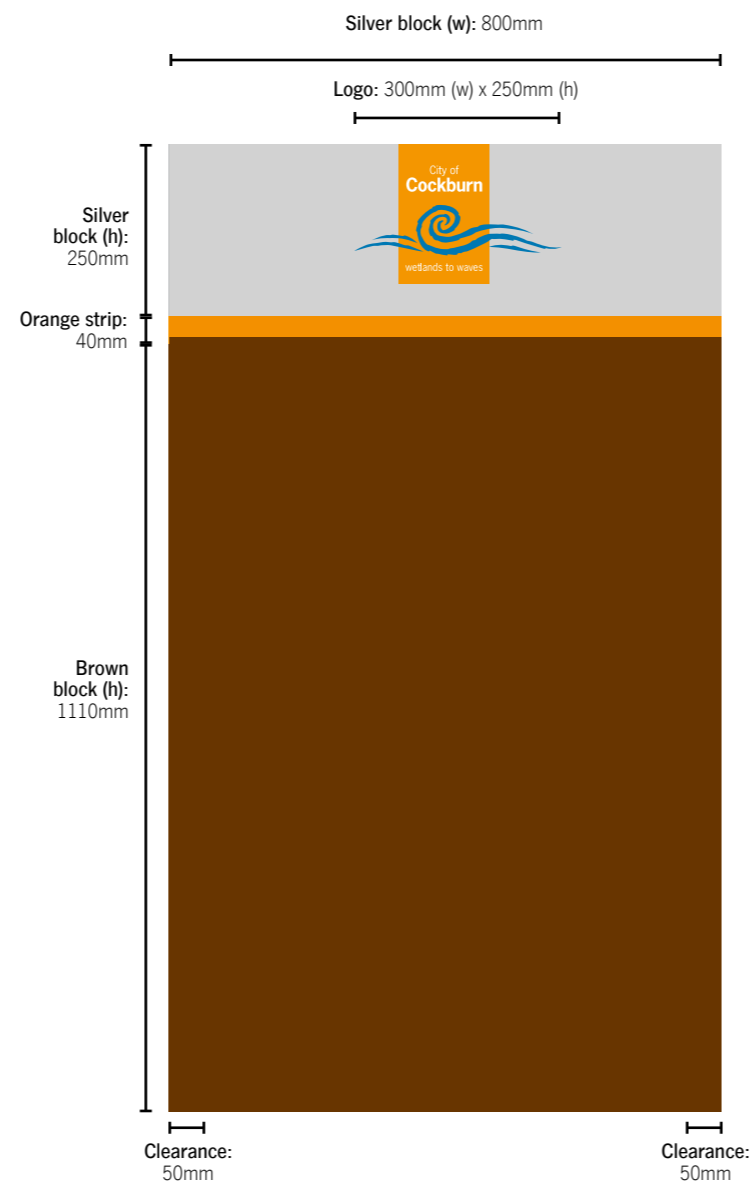

7.3 Secondary park entry sign B

These signs will be used along walkways and paths around the City of Cockburn parks. They are there to inform people about what is allowed and not allowed in the park.

Each sign includes:

- City of Cockburn colour palette
- City of Cockburn logo
- Park name
- Regional Park designated colour and logo
- Necessary symbols

Dimensions

300mm (w) x 1400mm (h)

300mm (w) x 900mm (h)

Regional parks

Where signs are installed in a Regional park then the relevant logo should be included in the designated symbol/logo area of the sign. This requirement is relevant to all Parks signs except 7.5, 7.7 and 7.8.

Regional parks sign system

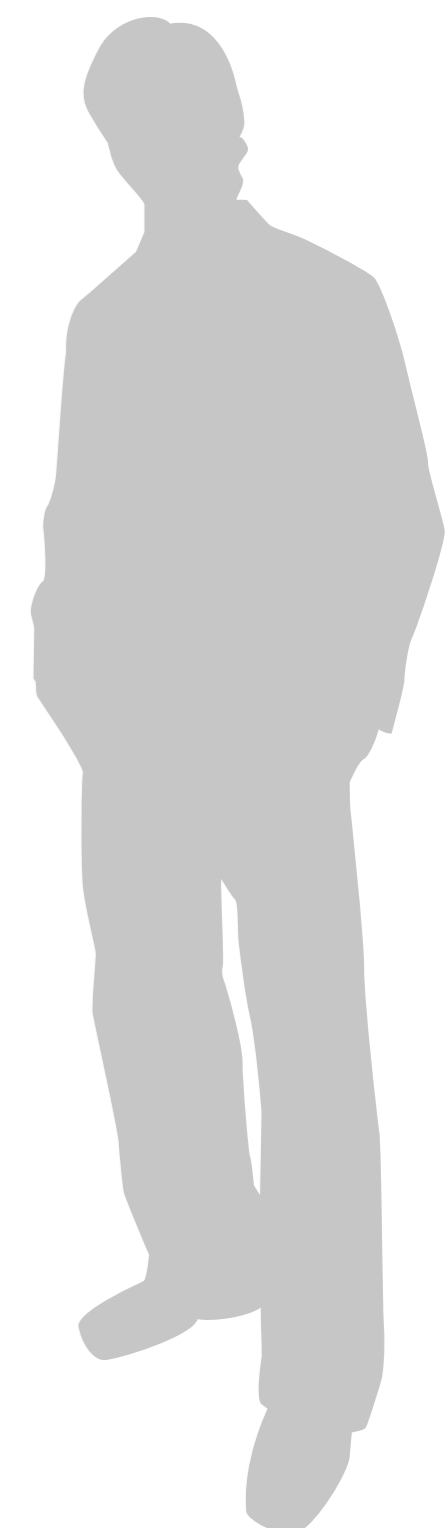
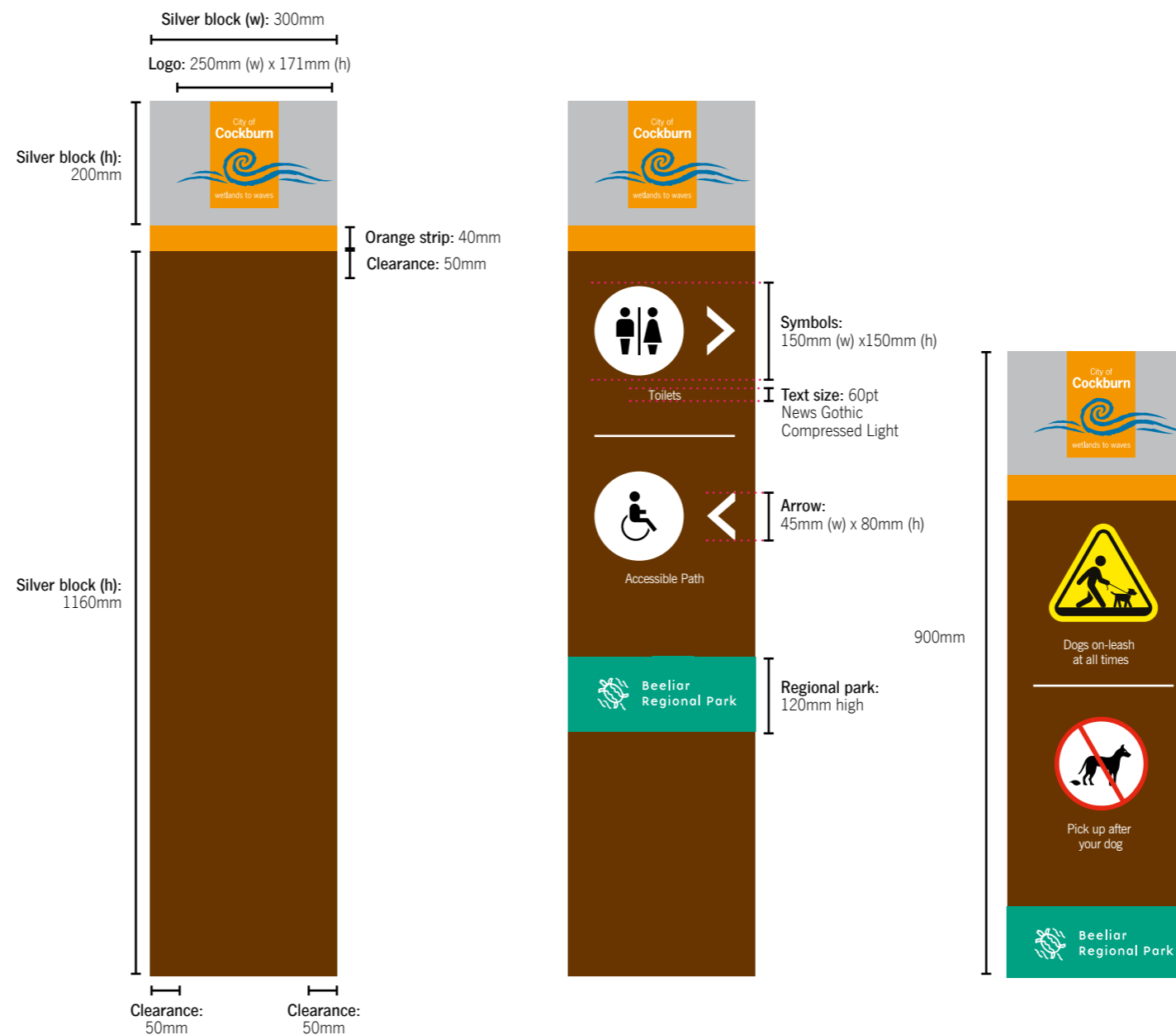
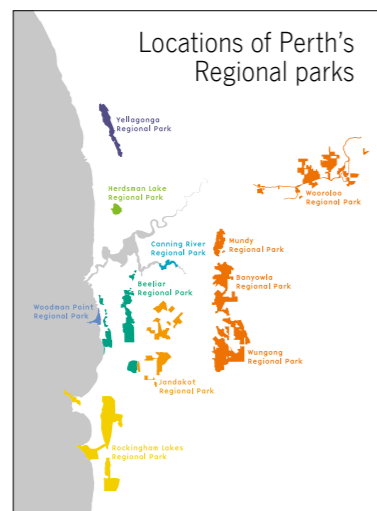

7.4 Primary park information sign

These signs are used to give details on the history of the park or reserve.

Symbols which will explain what can and cannot be done on the premisses of this park or reserve.

A directional map of the park or reserve with locations of points of interests within the park or reserve.

Each sign includes:

- City of Cockburn colour palette
- City of Cockburn logo
- *Park or reserve name
- *Image (heritage trail, map)
- *Nyungar - the sentence on Aboriginal/Nyungar history must be approved by the First Nations Community Development Officer/ Manager. At least two weeks notice must be given.

*optional (depending on the type of information on sign)

Options

1. Single sided (front panel only)
2. Double sided (front and back)
3. A-framed shelter (details TBC)

Dimensions

- 2400mm (w) x 1200mm (h)
- 1600mm (w) x 1200mm (h)
- 800mm (w) x 600mm (h)
- 400mm (w) x 300mm (h)
- 400mm (w) x 600mm (h)

Regional parks

Where signs are installed in a Regional park then the relevant logo should be included in the designated symbol/logo area of the sign. This requirement is relevant to all Parks signs except 7.5, 7.7 and 7.8.

Regional parks sign system

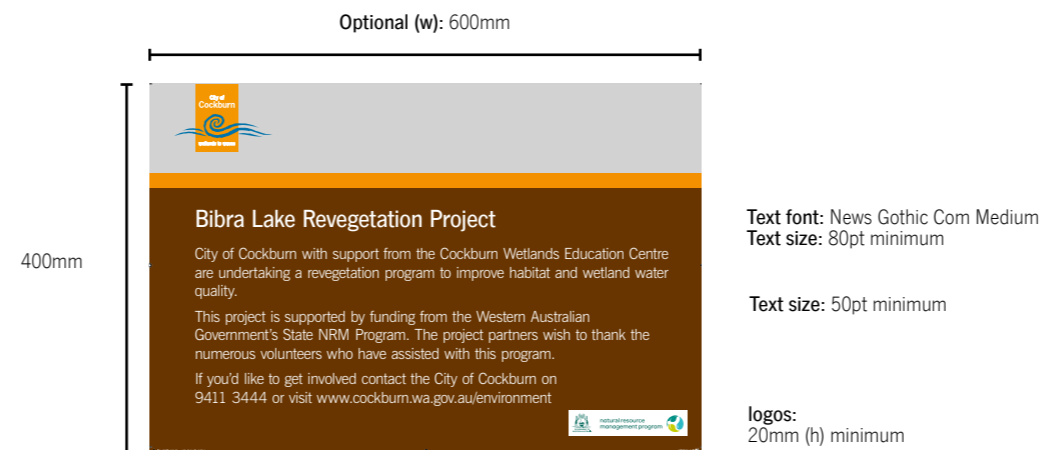
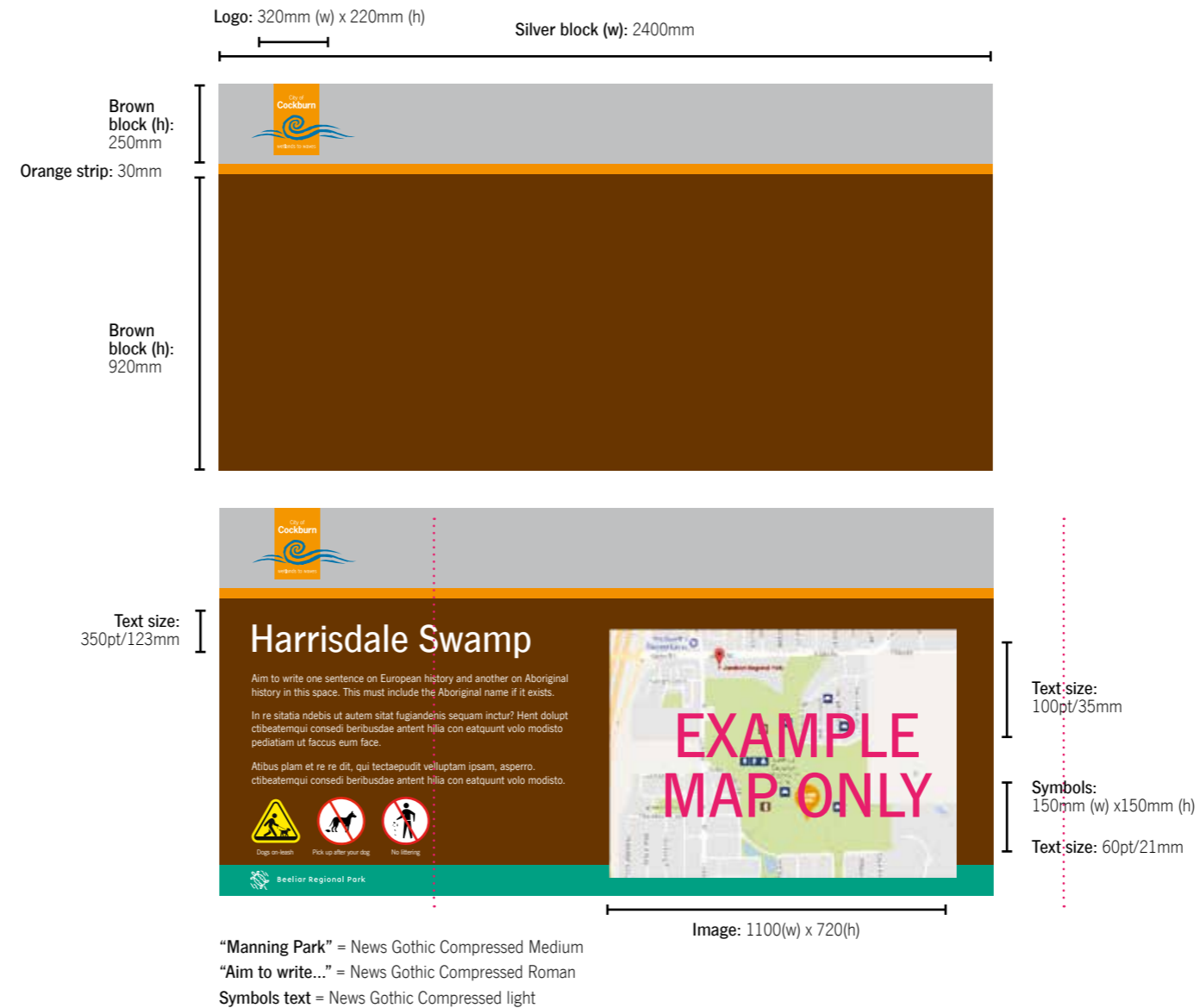

7.5 Location park information sign

These signs are used at points of interest within the park or reserve. Specific locations within the park will have these signs to give you a history of the location or provide you with a heritage trail.

Each sign includes:

- City of Cockburn colour palette
- City of Cockburn logo
- Park or reserve name
- Image (heritage trail, map)

Dimensions

350mm (w) x 1800mm (h)

Accessibility

Consideration should be given to audio and braille options.



7.6 Park wayfinding sign A

These signs are used between points of interest within the park or reserve.

Each sign includes:

- City of Cockburn colour palette
- Orange stripe
- Icons

Dimensions

200mm (w) x 900mm (h)

Accessibility

Consideration should be given to audio and braille options.

Regional parks

Where signs are installed in a Regional park then the relevant logo should be included in the designated symbol/logo area of the sign. This requirement is relevant to all Parks signs except 7.5, 7.7 and 7.8.

Regional parks sign system

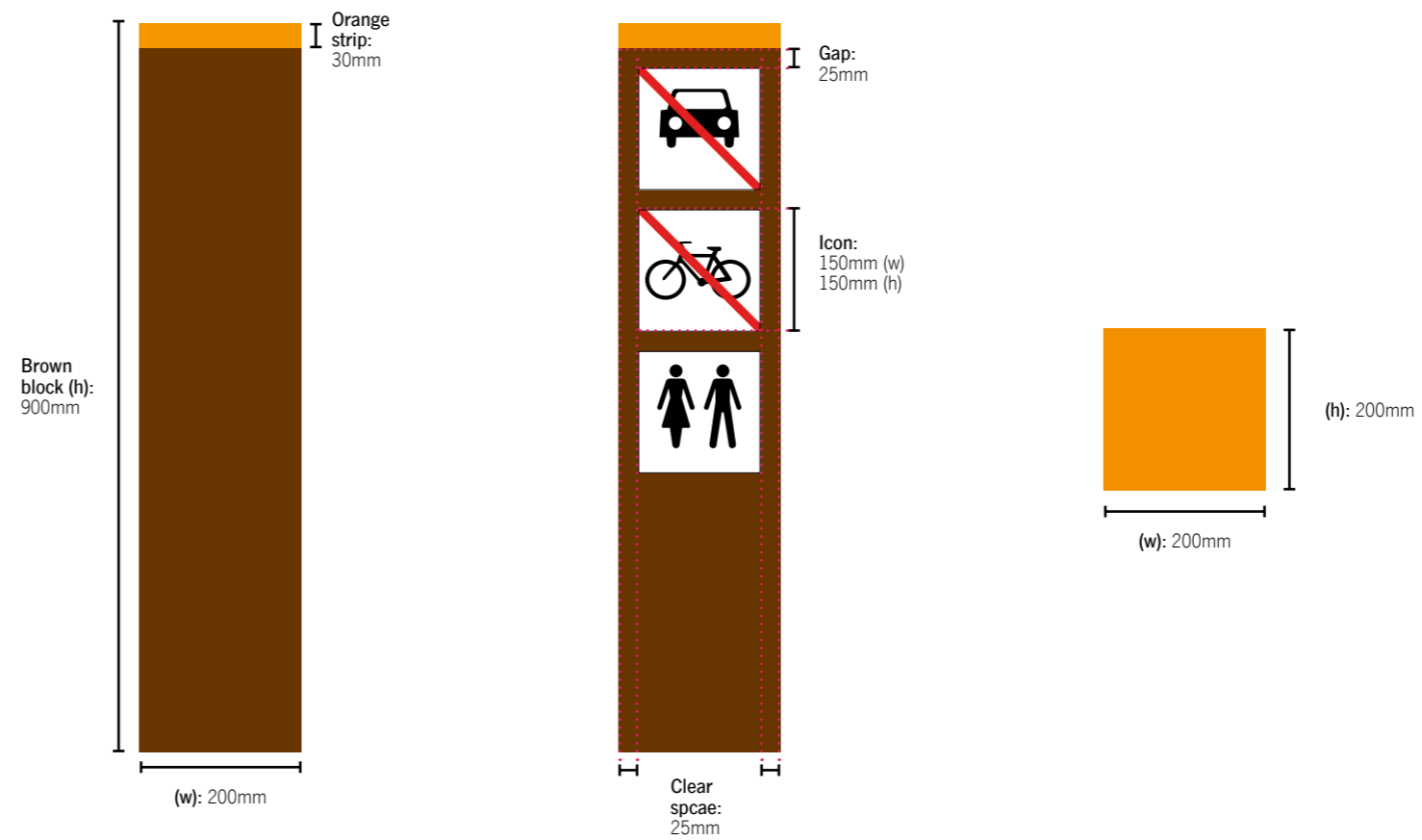

7.6 Park wayfinding sign B

These signs are used between points of interest within the park or reserve.

Each sign includes:

- City of Cockburn colour palette
- Core 10 material
- Descriptions, Maps, Icons, Supporter Logos

Dimensions

300mm (w) x 900mm (h)

Accessibility

Consideration should be given to audio and braille options.

Regional parks

Where signs are installed in a Regional park then the relevant logo should be included in the designated symbol/logo area of the sign. This requirement is relevant to all Parks signs except 7.1, 7.5 and 7.8.

Regional parks sign system

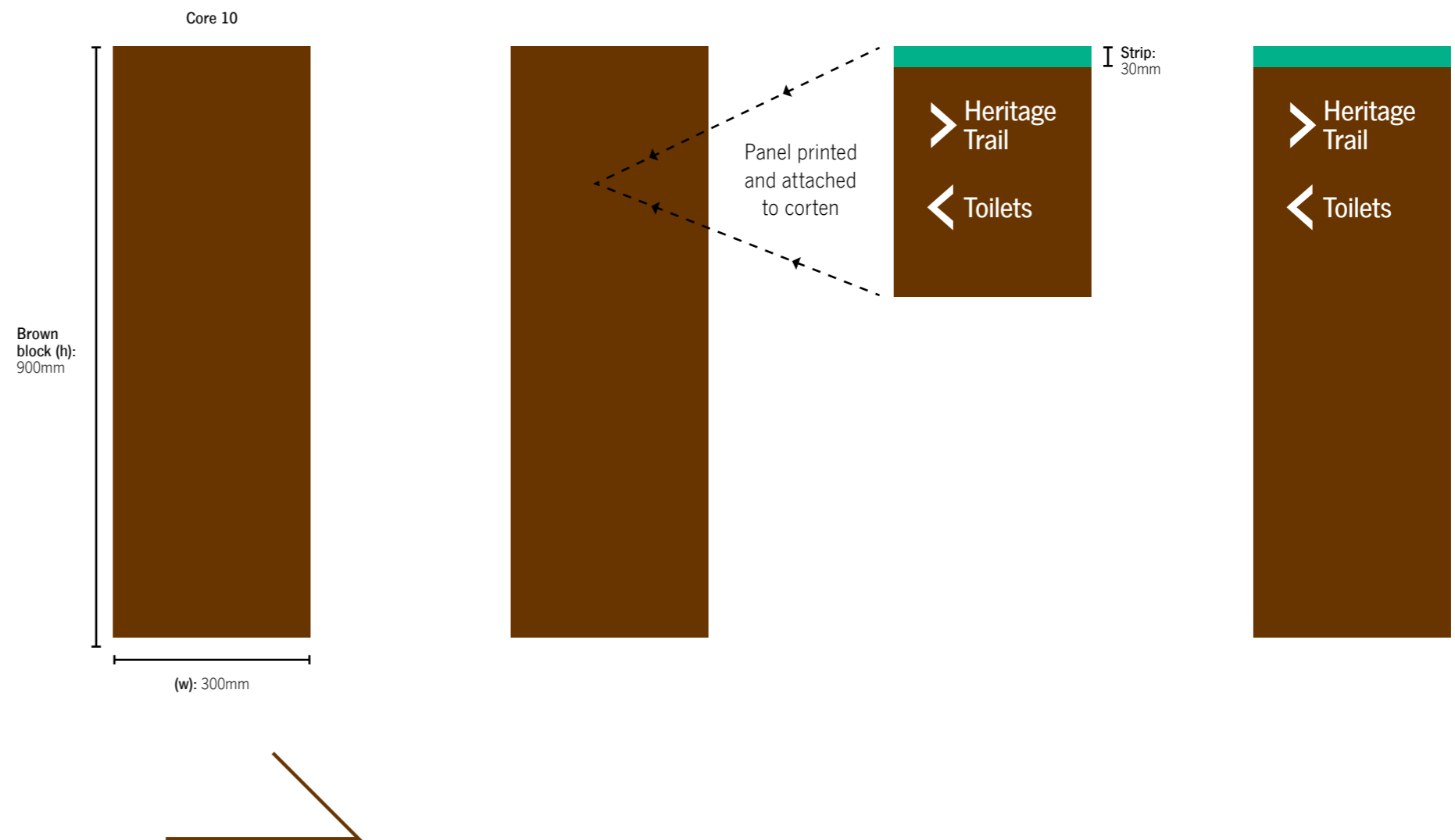

7.7 Park event A frame

These signs are used as directional and informational for park events. They will guide people or cars to the event parking or the event itself.

Each sign includes:

- City of Cockburn colour palette
- City of Cockburn logo
- Directional arrow if required

Dimensions

600mm (w) x 900mm (h)

Regional parks

Where signs are installed in a Regional park then the relevant logo should be included in the designated symbol/logo area of the sign. This requirement is relevant to all Parks signs except 7.5, 7.7 and 7.8.

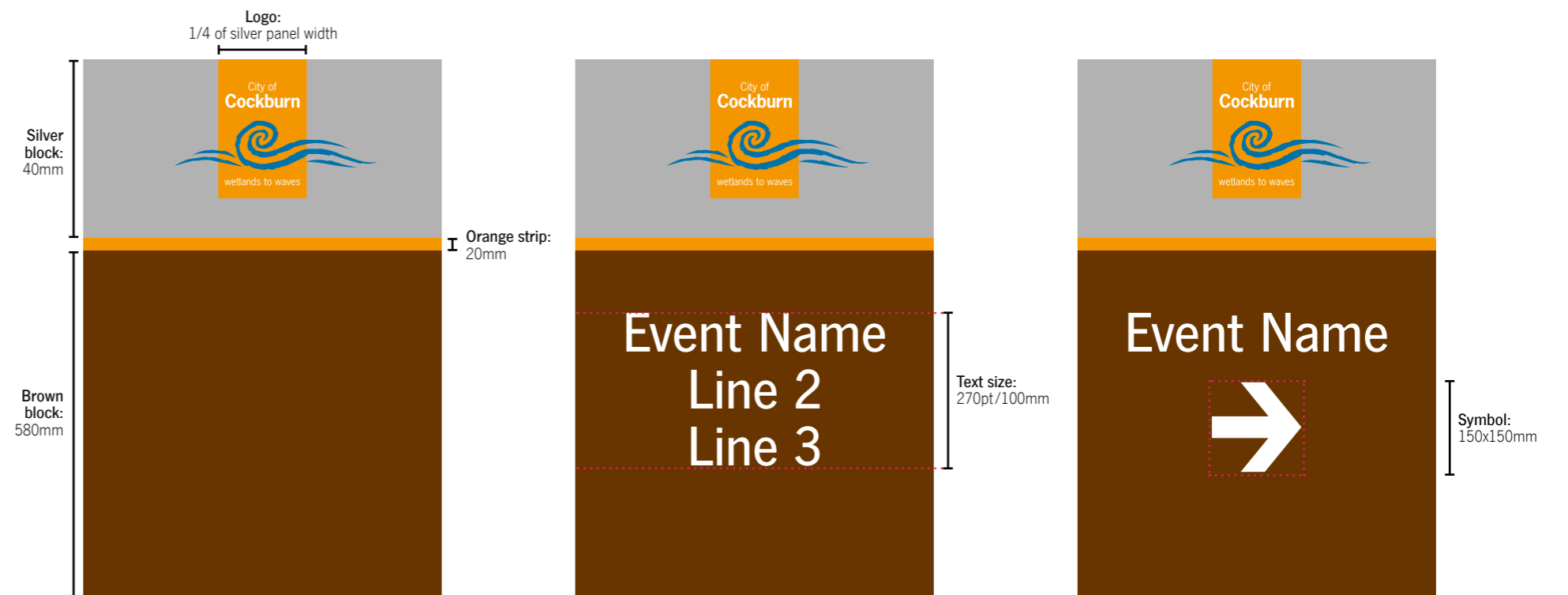

7.8 Park foot path stencil

These stencils are used as directional and informational for events and promotional. Wording, graphics and size made to order for each individual event. Example shown right.

Dimensions

750mm (w) x 1m (h)



7.9 Boundary access signage

These signs will be used at gate entrance around the City of Cockburn Park Reserve. They are there to inform people about what is allowed and not allowed in the park.

Each sign includes:

- City of Cockburn colour palette
- City of Cockburn logo
- Park name
- Gate number
- Regional Park designated colour and logo
- Necessary symbols
- One sentences on CoSafe contact phone number and surveillance
- One sentences on the Emergency Services vehicle uses.

Dimensions

594mm (w) x 420mm (h)

Regional parks

Where signs are installed in a Regional park then the relevant logo should be included in the designated symbol/logo area of the sign. This requirement is relevant to all Parks signs except 7.5, 7.7 and 7.8.

Regional parks sign system



Logo:
70mm h

420mm

Orange square:
100mm (h) x 100mm (w)

Yangebup Lake Reserve

GATE

1

Fire vehicle access

Keep clear at all times

In cases of emergency contact CoSafe on 1300 267 233

Notice: Area under surveillance

Collection of firewood from City of Cockburn reserves is prohibited penalties of up to \$5,000 apply.

Text font: News Gothic Com Medium
Text size: 120pt minimum

Text font: News Gothic Com Roman
Text size: 110pt minimum

Text font: News Gothic Com Roman
Text size: 50pt minimum

Text font: News Gothic Com Bold
Text size: 50pt minimum

Icon size: 45mm (h) minimum

Icon size: 45mm (h) minimum

Orange square:
100mm (h) x 100mm (w)

GATE

1

Text font: News Gothic Com Bold
Text size: 86pt minimum

Text font: News Gothic Com Black
Text size: 190pt minimum

7.10 Dieback protection area sign

These signs will be used at gate entrance around the City of Cockburn Park Reserve. They are there to inform people about Dieback Protection and Prevention.

Each sign includes:

- City of Cockburn colour palette
- City of Cockburn logo
- The Department of Biodiversity, Conservation and Attractions (DBCA) with Parks and Wildlife service logo
- Main heading
- Necessary symbols
- One sentences on Dieback spread
- One sentences on Dieback prevention
- One sentences on the Dieback risk.

Dimensions

300mm (w) x 300mm (h)

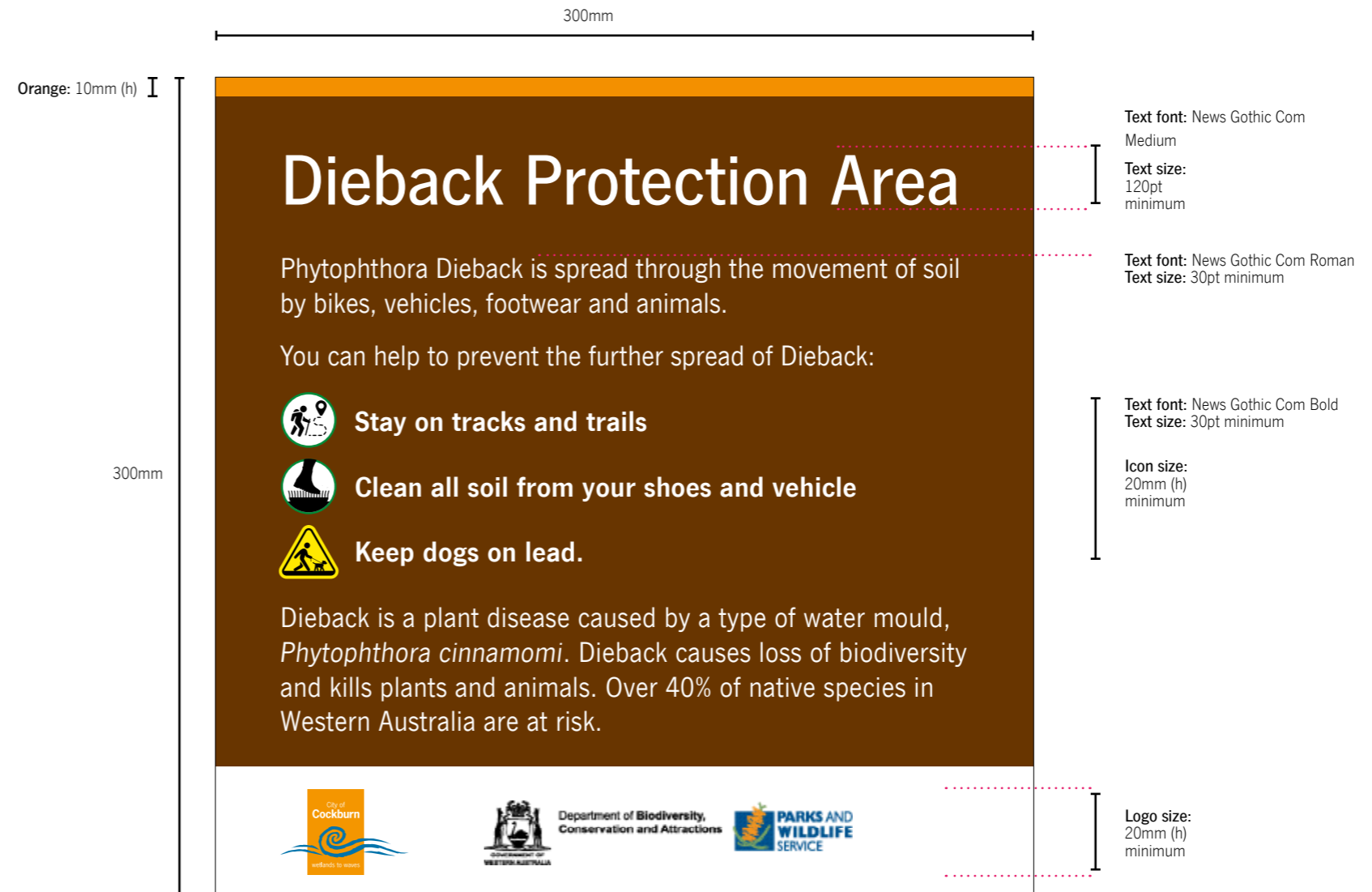

8.0 Interpretive signs



What is Interpretive signage

Interpretive signage is signage that helps to tell a story and/or educate, that promotes local heritage and teaches sustainable practices. Interpretive signage is not directional signage but they will often follow a natural progression. Signage is not the only important component of interpretation – people, props, artefacts and other tools can be used. But here we deal with the signage component.

The examples within are based on conventional interpretive sign sizes but can be adapted according to location and needs.

While the design must adhere to the corporate design examples there is some leeway with Interpretive signage.

There are consultants who specialise in Interpretive signage and in most cases it is recommended that a specialist is engaged.

Officers must consider any opportunity to incorporate Nyungar language within signage. Please consult with Communications and Marketing if you need guidance.

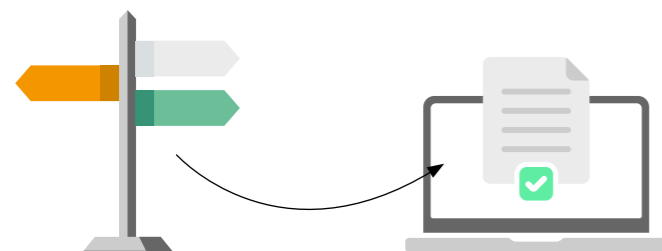

Signs need to be registered in the sign register

For new signs, upgrades and removal of existing signs please contact assets@cockburn.wa.gov.au for further information

This is a monitored inbox, we can discuss the requirements and provide a solution as to how best they should be captured and added to the register.

Layout

Each sign generally consists of a front only with the following details:

- City of Cockburn Logo (positioned in top left corner)
- Title
- Introduction
- Sponsor partners if applicable (liaise with marketing and communications for positioning.)
- Sign layouts caters for streakers, strollers, and studiers by having:
 - A large enough heading if you are streaking past
 - A teaser sentence for those strolling past
 - Body text 25 pt minimum for those who stop to study the sign.

Symbols and icon

- Sign location
- Access gate
- Seat
- Vista
- Numbers
- Sealed path
- Limestone path
- Interpretive walk

Writing guide

- A** Nyungar Name
News Gothic Com Medium
- B** Scientific Name
News Gothic Com Italic
- C** Common Name
News Gothic Com Bold
- D** Description
News Gothic Com Roman

Mangatj ← **A**
Banksia illicifolia
Holly-leaf Banksia
Tree to 10m tall with distinctive holly-like leaves and flowers that blossom all year round. Its flowers change colour from cream to deep red to increase chances of pollination.

Mangatj ← **B**
Banksia attenuata
Slender Banksia
Shrub, or small tree with yellow candle-like flowers, blossoming over Spring and Summer.

Kaal Mangatj ← **C**
Banksia menziesii
Firewood Banksia
Tree to 10m tall with orange-red flowers and oblong leaves, flowering through the cooler months from Autumn through to Spring.

D

Banksia flower heads are made up of many of tiny individual flowers grouped together. They produce large volumes of nectar and attract many birds and small mammals to feed on them. Banksias are excellent plants to encourage native animals to your garden.

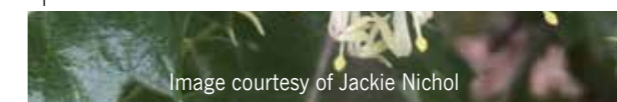

Type A. Photo credit text: Image courtesy of <full name>

Type B.
Photo credit text:
<<Subject name>>
© <full name>

Feed a bird? How absurd!

Birds are highly adapted to feeding themselves. Can you see them dive, wade, dabble, upend or even soar above the water?

Look out for special adaptations such as leg length and bill shape which enable birds to source different foods from different parts of the wetland.

Most of us have fed bread to waterbirds before, but did you know this can lead to sickness, disease, food dependency and aggression?

Food waste can also reduce water quality, contributing to toxic algal blooms and nuisance midges.

Help keep our wetlands healthy and observe our local birds by borrowing binoculars or a mini binoculars pack from the City, or get involved in local bird surveys.

www.cockburn.wa.gov.au | 08 9411 3444

1. Eurasian Coot, feeding fledgling © The Wetlands Centre
2. Australasian Grebe and fledglings © The Wetlands Centre
3. Purple Swamphen © Georgina Steytler

Structure for facility and building signs

Below is a list and sizes of all the **interpretive** signs for the City of Cockburn.

Dimensions

1000mm (w) x 650mm (h)

800mm (w) x 600mm (h)

600mm (w) x 400mm (h)

400mm (w) x 300mm (h)

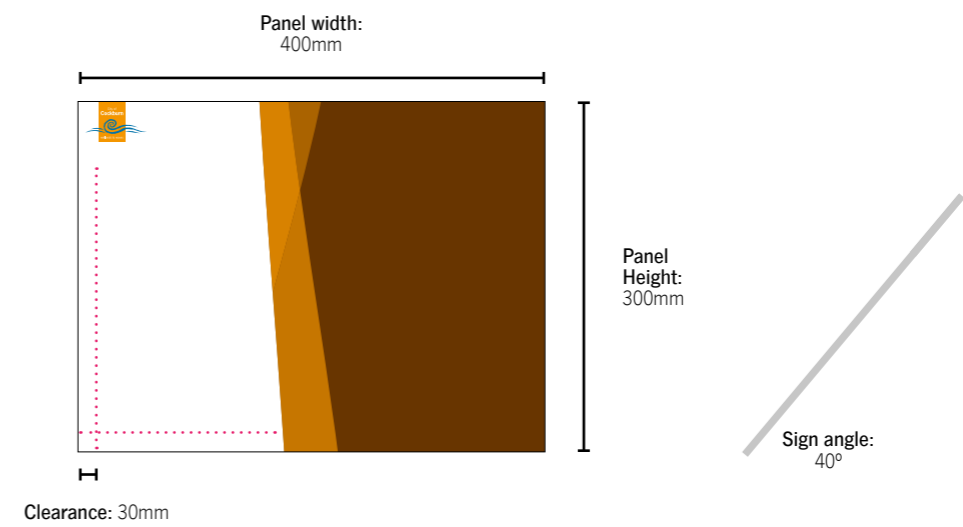
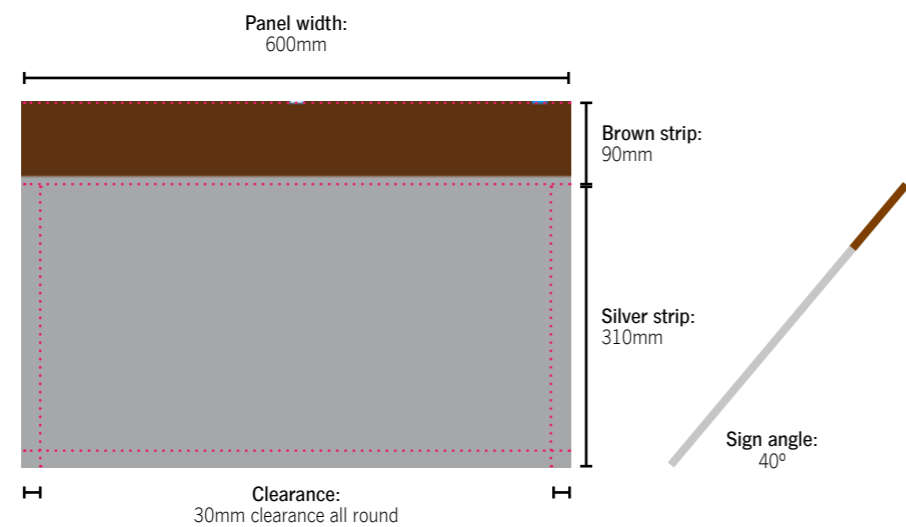
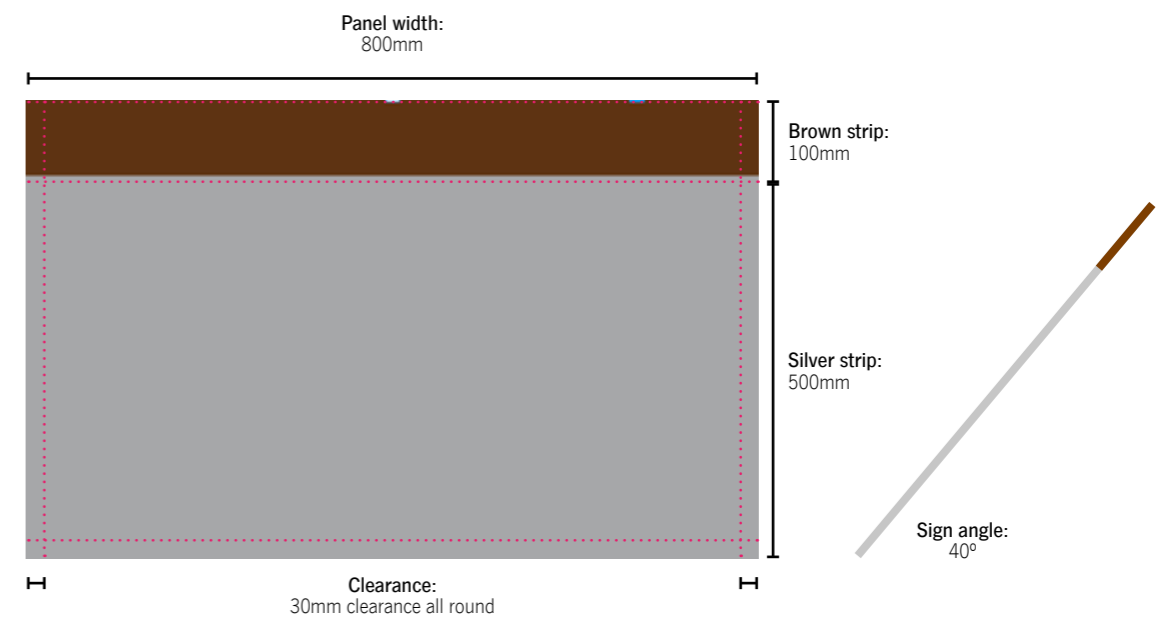
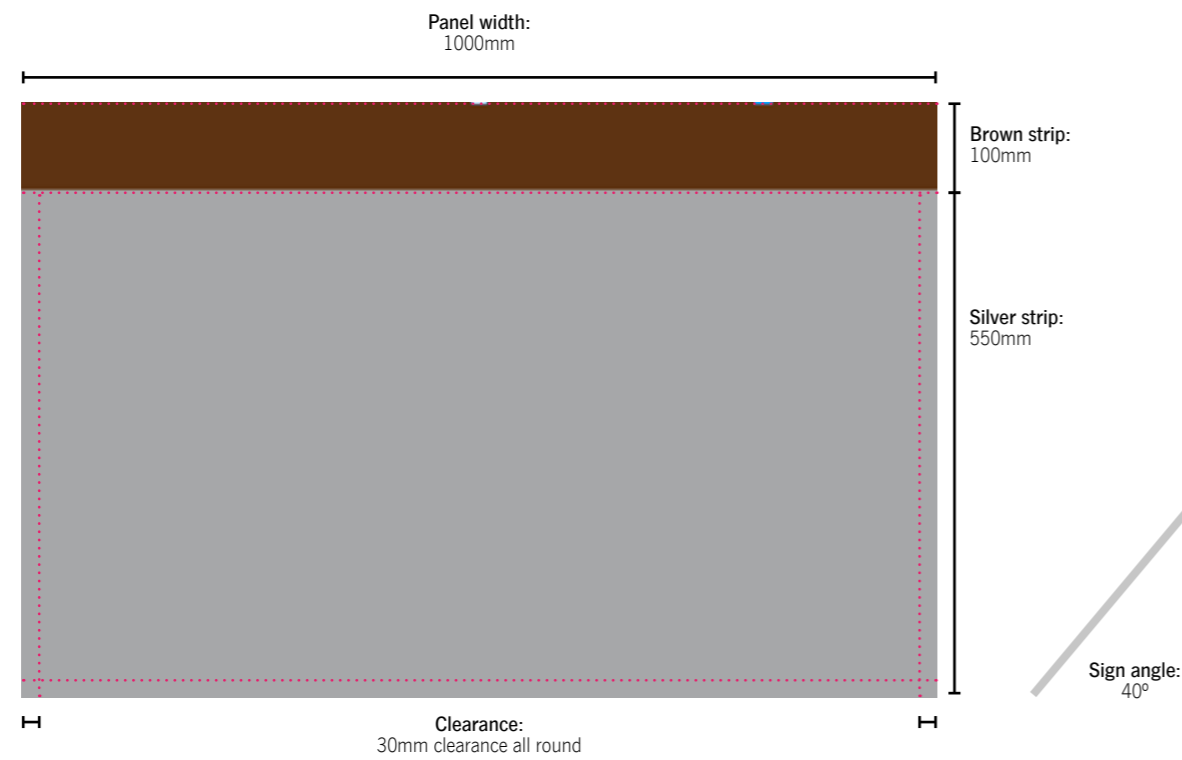

8.1 Interpretive signage

These signs are used at points of interest within the park or reserve. Specific locations within the park will have these signs to give you a history of the location or provide you with a heritage trail.

Each sign includes:

- City of Cockburn colour palette
- City of Cockburn logo
- Historical/locality information
- Photo, maps or walking trail as required.

Dimensions

- 1000mm (w) x 650mm (h)
- 800mm (w) x 600mm (h)
- 600mm (w) x 400mm (h)
- 400mm (w) x 300mm (h)

Partnership logos

Position bottom left or bottom right with appropriate clear space. Seek approval from partner/sponsor.

Accessibility

Consideration should be given to audio and braille options.

Regional parks

Where signs are installed in a Regional park then the relevant logo should be included in the designated symbol/logo area of the sign. This requirement is relevant to all Parks signs except 7.1, 7.5 and 7.8.

Regional parks sign system

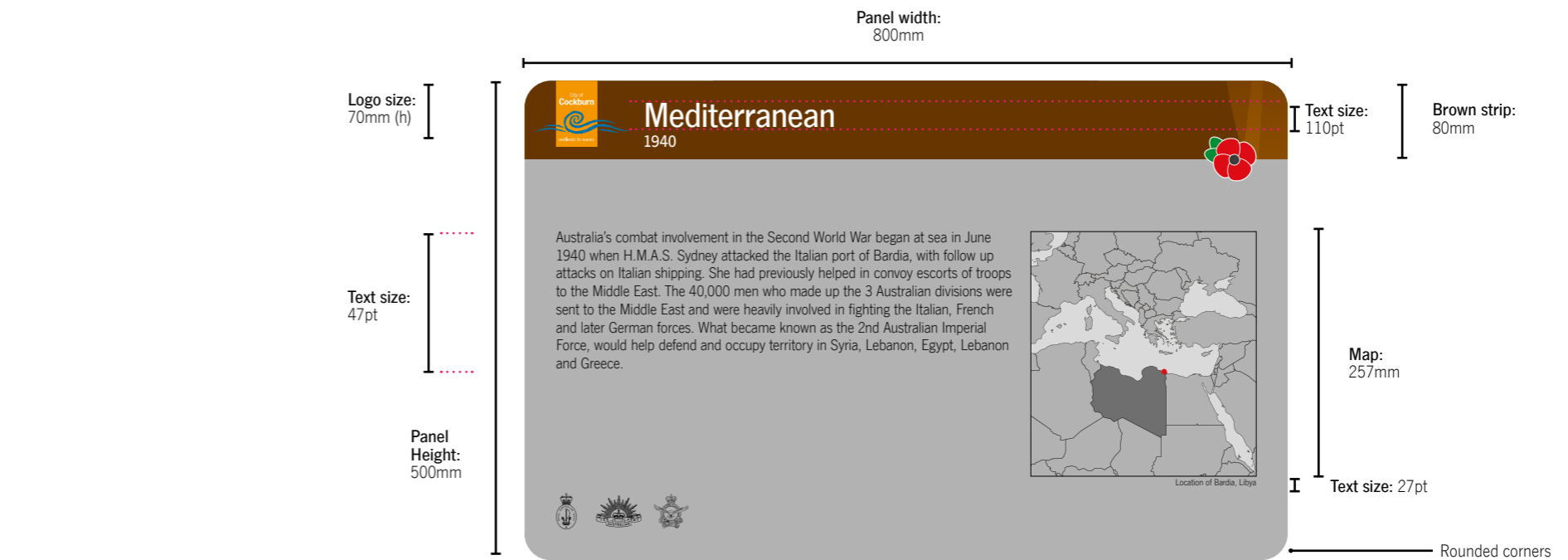

Cockburn Central West Memorial Walk Signage

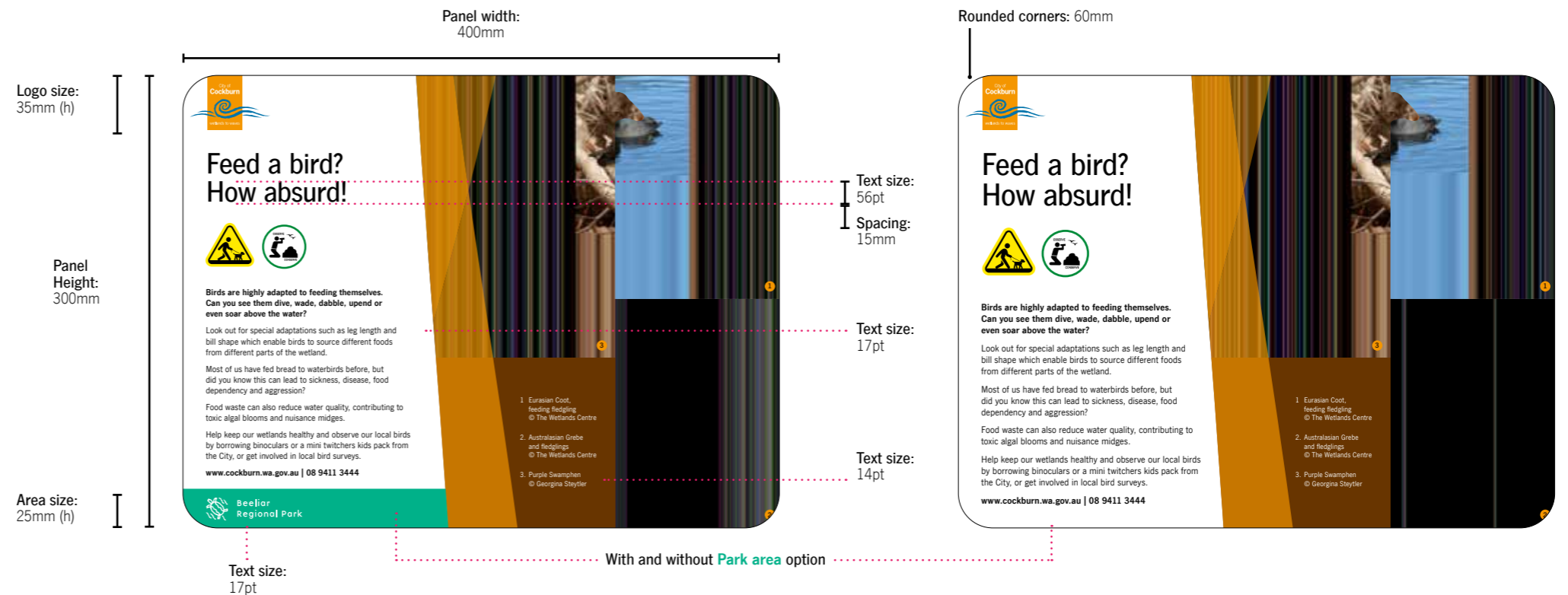

With and without Park area option

8.1 Interpretive Sign Types

These signs are used at points of interest within the park or reserve. Specific locations within the park will have these signs to give you more information.

Each sign includes:

- City of Cockburn colour palette
- City of Cockburn logo
- Historical/locality information
- Photo, maps or walking trail as required.

Dimensions

- 1000mm (w) x 650mm (h)
- 800mm (w) x 600mm (h)
- 600mm (w) x 400mm (h)
- 400mm (w) x 300mm (h)

Partnership logos

Position bottom left or bottom right with appropriate clear space. Seek approval from partner/sponsor.

Accessibility

Consideration should be given to audio and braille options.

Regional parks

Where signs are installed in a Regional park then the relevant logo should be included in the designated symbol/logo area of the sign. This requirement is relevant to all Parks signs except 7.1, 7.5 and 7.8.

Regional parks sign system

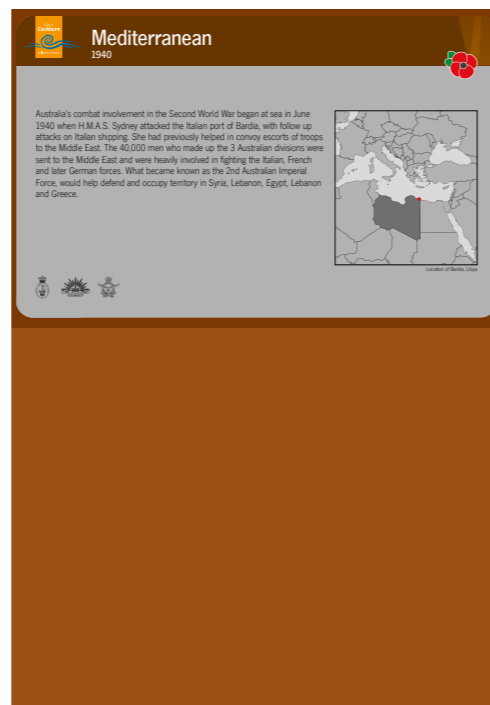

- Type 1:**
- Sign mounted on rail
 - With base plate (Core 10/powdercoated)

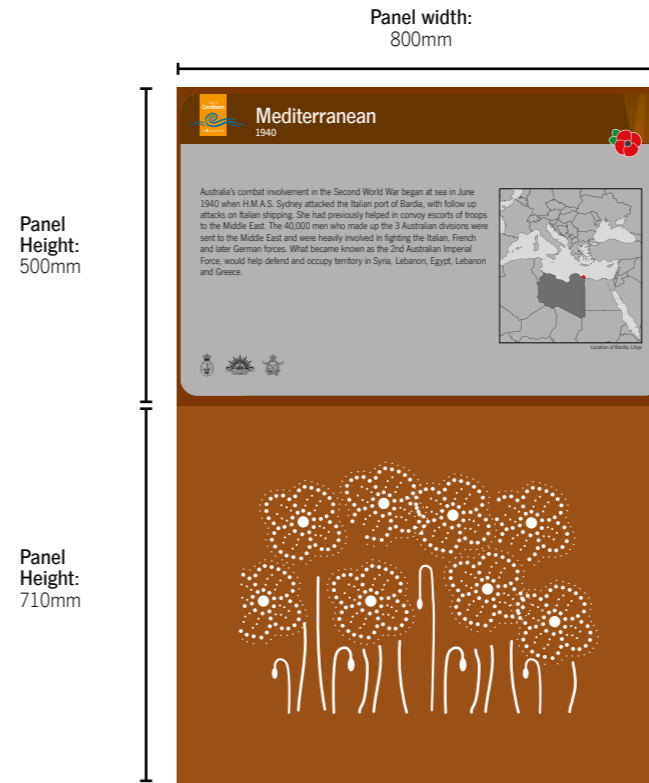

- Type 2:**
- Mounted on rail
 - With base plate (Core 10/powdercoated)
 - Design motif laser cut into base plate

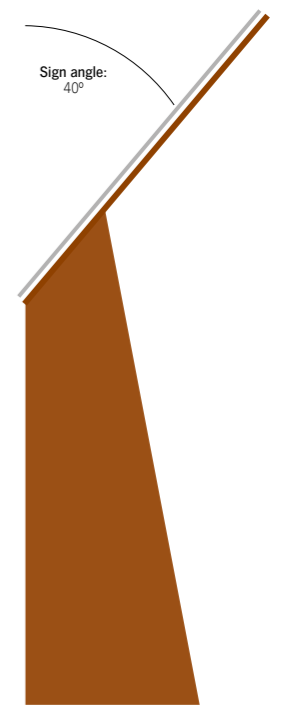

Rounded corners: 60mm

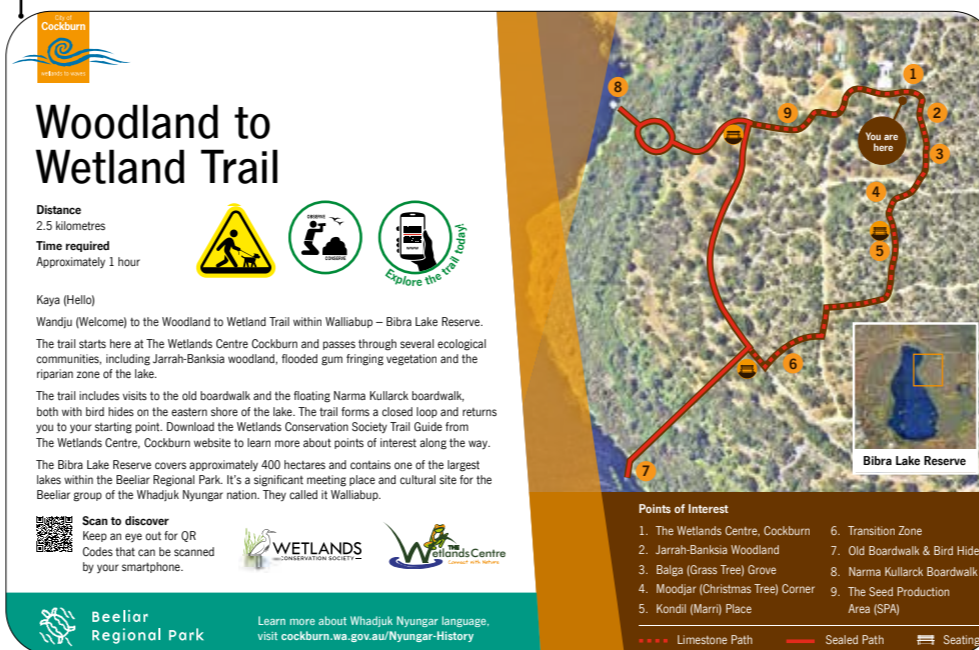

Interpretive sign
1000mm x 650mm

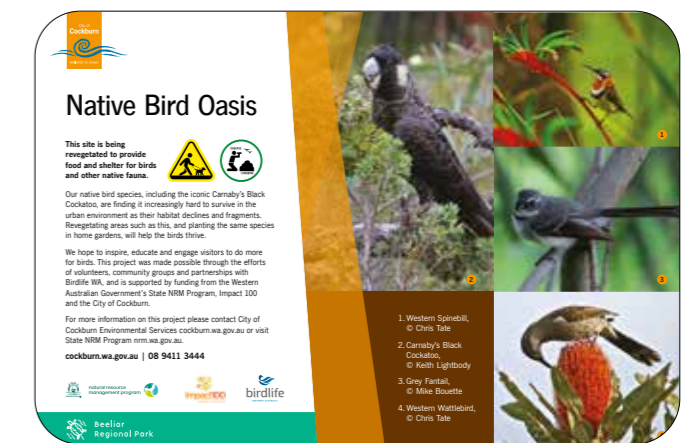

Interpretive sign
600mm x 400mm

9.0 Project signs



Temporary project signage is to be used to inform the community about temporary maintenance and works projects that are carried out by the City of Cockburn or their contractors.

When to use temporary project signage

It applies to those projects that are:

- highly visible
- will take more than two days to complete
- will cause inconvenience to the public and/or
- will require the project to be fenced off.

Temporary project signage does not apply to small maintenance projects that are completed over the course of a day and City officers are in attendance for the duration of the project.

Temporary project signage should be placed in one or more prominent locations at the project site at least 24 hours prior to the commencement of the project and be removed immediately the project is completed.

Should delays occur to the project that result in a later completion date than indicated on the signage, the signage is to be changed immediately to indicate the new completion date.

Communication process

- Ensure the project is registered in the CRM system
- Update the 'maintenance and road works' calendar on www.cockburn.wa.gov.au
- Discuss project with marketing and communication for inclusion in marketing material
- Arrange letter drop to advise residents and or businesses (if required).

Layout

Each sign consists of a front only with the following details:

- Title of the project
- Short description*
- Completion date
- Regret inconvenience sentence
- Contact information: cockburn.wa.gov.au or 08 9411 3444
- City of Cockburn Logo (positioned in bottom right corner)
- Project cost
- Sponsor partners (liaise with marketing and communications for positioning)

*Two different text options are shown on the next page for this sentence(s).

9.1 Project signs

These signs are used for upcoming developments and projects happening within the City of Cockburn. The signs will be placed on the sites of the development or project.

Each sign includes:

- City of Cockburn colour palette
- City of Cockburn logo
- Project name
- Image

Dimensions

3000mm (w) x 2000mm (h)



“Aboriginal Cultur...” = News Gothic Compressed Medium

“Total project...” = News Gothic Compressed Medium

“Design and...” = News Gothic Compressed Roman

10.0 Beach warning, access and directional signs

10.1 Beach hazard signs

These signs are used for any beach in the City of Cockburn area. They provide information of the hazards and dangers before entering the beach. Signs must follow must be in accordance with the current Australian Standards.

Australian Standards

- Australian/New Zealand Standard AS/NZS 2416.1:2010
Water safety signs and beach safety flags Part 1: Specifications for water safety signs used in workplaces and public areas (ISO 20712-1:2008, MOD)
- Australian/New Zealand Standard AS/NZS 2416.2:2010
Water safety signs and beach safety flags Part 2: Specifications for beach safety flags – Colour, shape, meaning and performance (ISO 20712-2:2007, MOD)
- Australian/New Zealand Standard AS/NZS 2416.3:2010
Water safety signs and beach safety flags.

Signage Manual - National Aquatic Recreation - 2006 - Third Edition:
Docset ID: 10149766

Water safety signs and beach safety flags
Part 1: Specifications for water safety signs used in workplaces and public areas (ISO 20712-1 :2008, MOD): Docset ID: 10170092

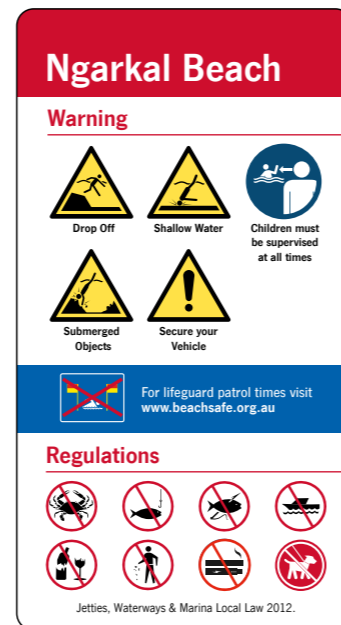

Warning sign example



Warning sign example

10.2 Beach closure/access and directional signage

All beach closure, access and directional signage must be in accordance with the current Australian Standards.

Australian Standards

- Australian/New Zealand Standard AS/NZS 2416.1:2010
Water safety signs and beach safety flags Part 1: Specifications for water safety signs used in workplaces and public areas (ISO 20712-1:2008, MOD)
- Australian/New Zealand Standard AS/NZS 2416.2:2010
Water safety signs and beach safety flags Part 2: Specifications for beach safety flags – Colour, shape, meaning and performance (ISO 20712-2:2007, MOD)
- Australian/New Zealand Standard AS/NZS 2416.3:2010
Water safety signs and beach safety flags.



Warning sign example

11.0 Regulatory signs



11.1 CoSafe security sign

These signs are used around buildings and facilities around the City of Cockburn area. They are to warn and inform people of the security which the City of Cockburn and CoSafe implement.

Each sign includes:

- City of Cockburn colour palette
- City of Cockburn logo
- CoSafe name
- Security message or picture

Dimensions

300mm (w) x 450mm (h)

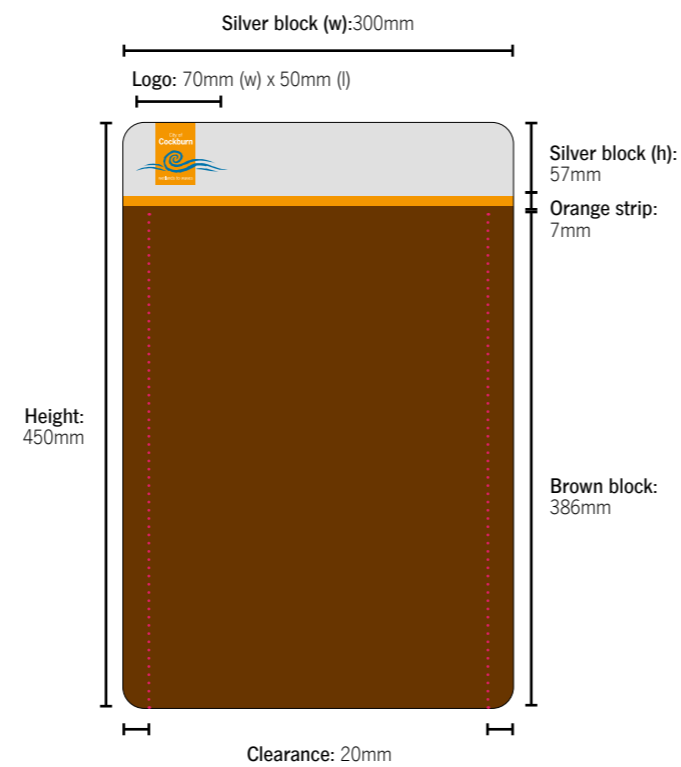

“CoSafe” = News Gothic Compressed Medium
 “If any Anti...” = News Gothic Compressed Roman
 Numbers = News Gothic Compressed Medium



“CoSafe” = News Gothic Compressed Medium
 “CCTV operate...” = News Gothic Compressed Medium



11.2 Dog related signs

These signs are used in parks to advise if dogs must be on leash or may be off leash and advise availability of Poo-ch pouches.

Each sign includes:

- City of Cockburn colour palette
- City of Cockburn logo
- Website address - specific page

Dimensions

- 300mm (w) x 450mm (h)
- 300mm (w) x 400mm (h)

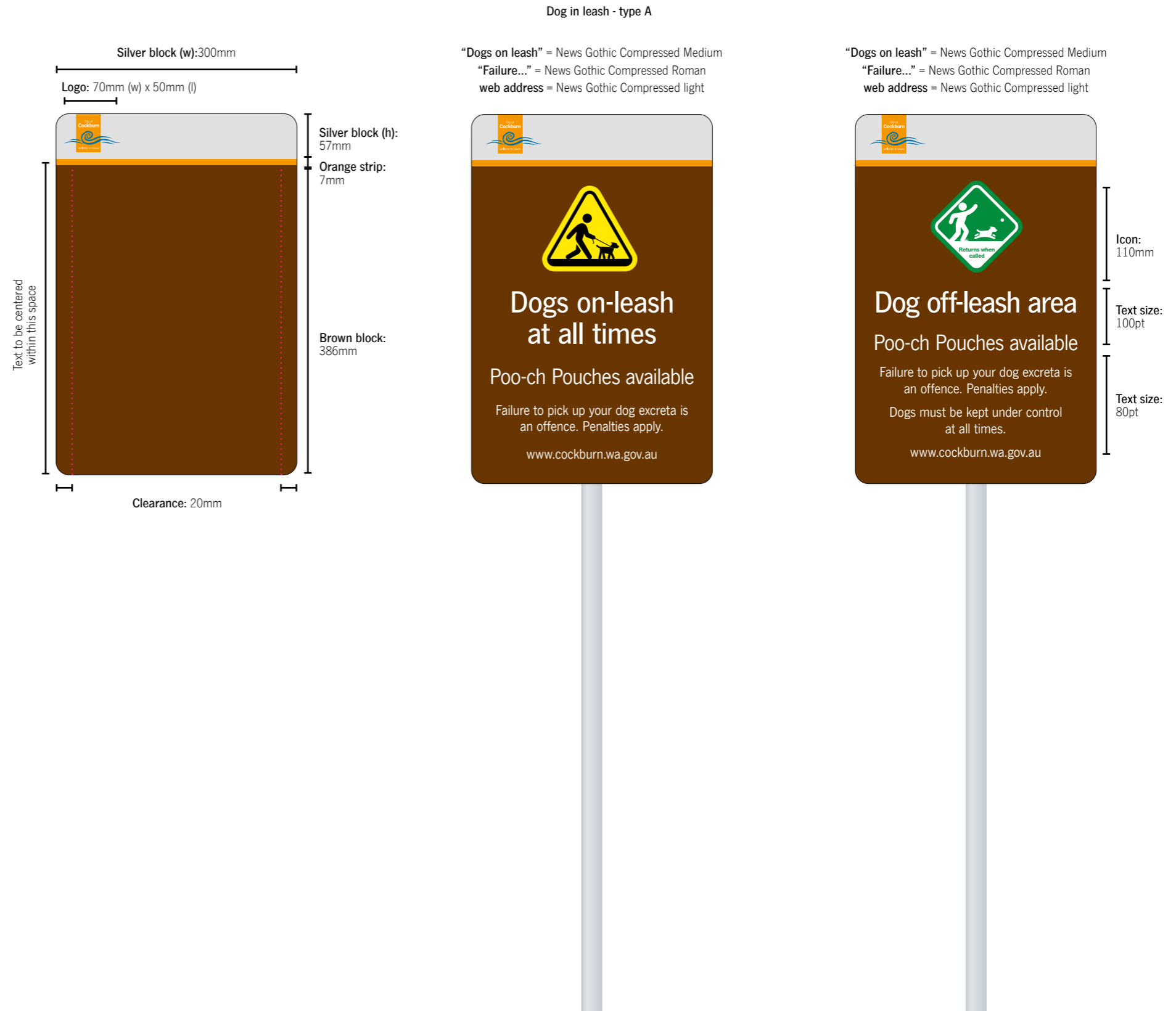

11.3 Poo-ch pouch signs

These signs are used in parks to advise if dogs must be on leash or may be off leash and advise availability of Poo-ch pouches.

Each sign includes:

- City of Cockburn colour palette
- City of Cockburn logo
- Main info plate
- Thank you plate
- Poo-ch pouches sticker.

Dimensions

450mm (w) x 600mm (h) – Main

450mm (w) x 300mm (h) – Thank you

211mm (w) x 112mm (h) – Poo-ch Pouches



11.4 Activities not permitted

These signs are used around buildings and facilities to advise people of activities that are not permitted.

Each sign includes:

- City of Cockburn colour palette
- City of Cockburn logo

Dimensions

300mm (w) x 450mm (h)

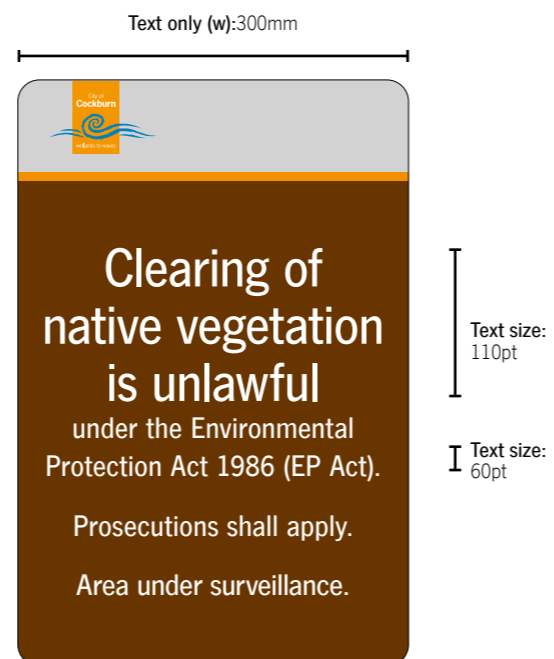
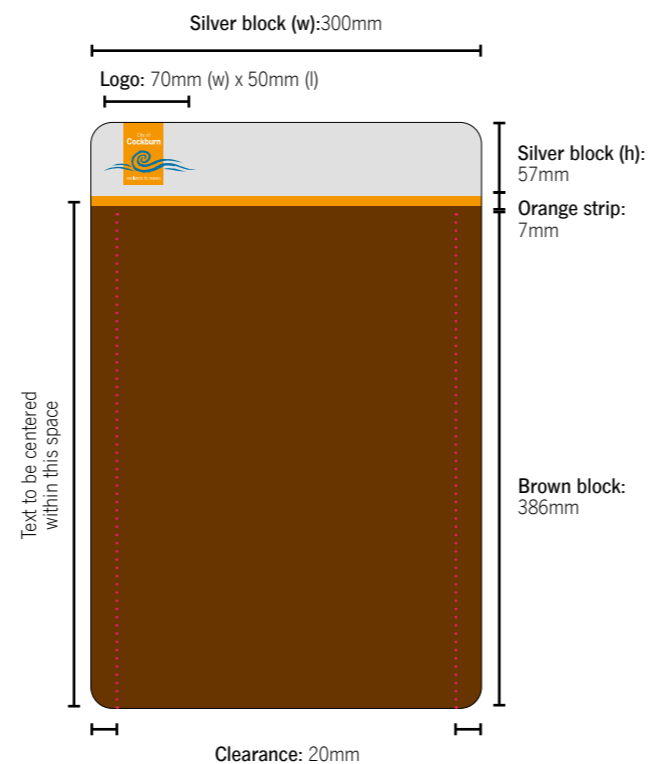

"No camping" = News Gothic Compressed Medium
 "Penalties..." = News Gothic Compressed Light

"Trespassers..." = News Gothic Compressed Medium
 "Penalties..." = News Gothic Compressed Light



11.5 Health warnings

These signs are used to provide health related warnings.

Each sign includes:

- Yellow background
- Diamond icon with exclamation mark
- Phone number
- Website address
- City of Cockburn logo (mono)

Dimensions

300mm (w) x 450mm (h)



"Health Warning" = News Gothic Compressed Medium
 "This water..." = News Gothic Compressed Roman
 "T: 08 9411 3444..." = News Gothic Compressed Medium



11.6 On-street parking

All on street parking signage must be in accordance with the current Australian Standards. Including design (font, point size and symbols/graphics), manufacture, installation and position.

The visuals, shown right, are examples only.

Full details and specifications can be found in the following documents:

- Australian Standard - Parking facilities Part 5: On-street parking AS 2890.5-1993
- Australian Standard - Manual of uniform control devices Part 11: Parking controls AS 1742.11-1999

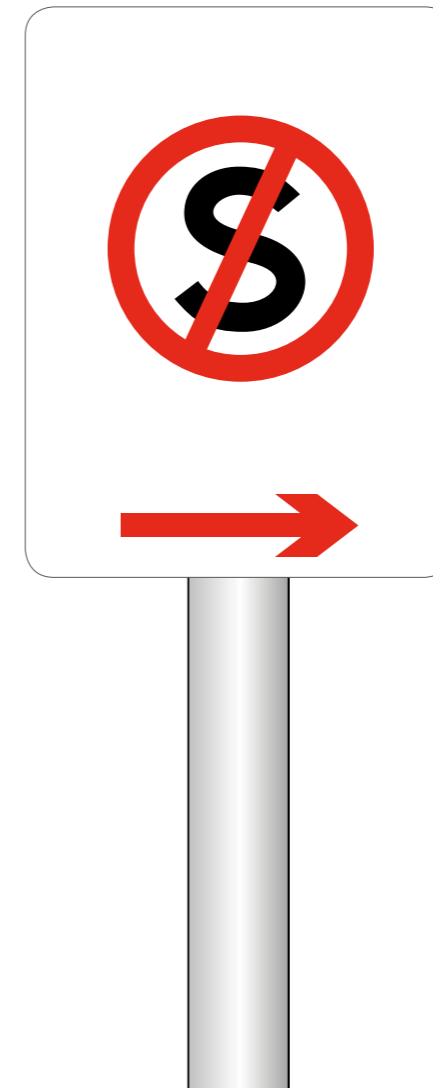

11.7 Car parks

These signs are used around buildings and facilities around the City of Cockburn area. They provide vital information for people who need to contact CoSafe.

Each sign includes:

- City of Cockburn colour palette
- City of Cockburn logo
- Phone number
- Website address

Dimensions

1200mm (w) x 800mm (h)

600mm (w) x 400mm (h)

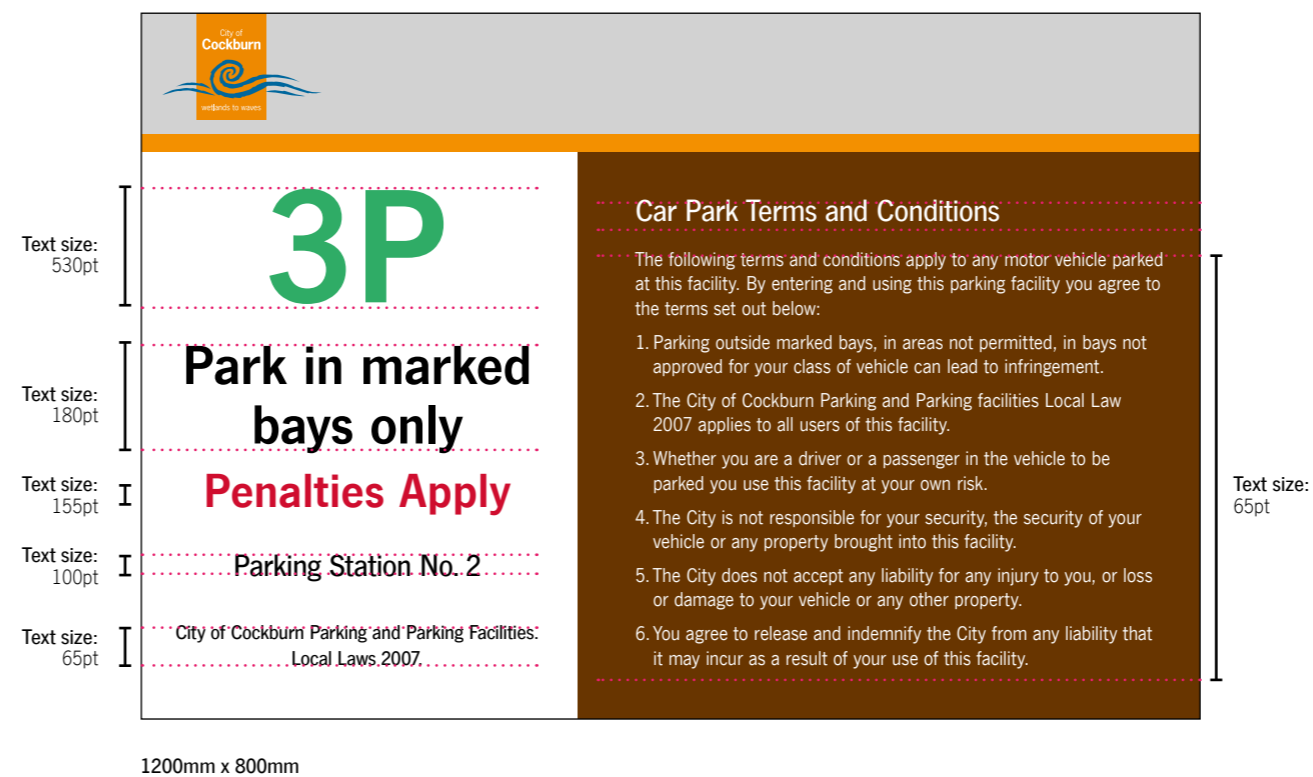

Silver block (h): 60mm
 Orange strip (h): 8mm
 White block (h): 332mm

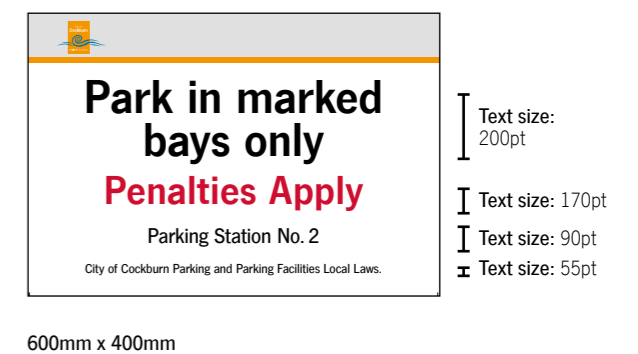

11.8 Proud to be smoke-free sign

These signs are used around buildings and facilities around the City of Cockburn area. To promote public health and create a family-friendly environment. By reducing the harms of smoking, they aim to protect the well-being of residents and minimize exposure to secondhand smoke.

Each sign includes:

- City of Cockburn colour palette
- Prohibitive icon with cigarette and electronic vape
- City of Cockburn logo
- Website address

Dimensions

300mm (w) x 450mm (h)



“Proud to...” = News Gothic Compressed Medium
 Website = News Gothic Compressed Roman



11.9 Shared path sign

These signs encourage predictable and courteous behaviours and to discourage distractions while walking, cycling and riding on our shared paths, trails and footpaths.

Each sign includes:

- City of Cockburn colour palette
- City of Cockburn logo

Dimensions

300mm (w) x 450mm (h)

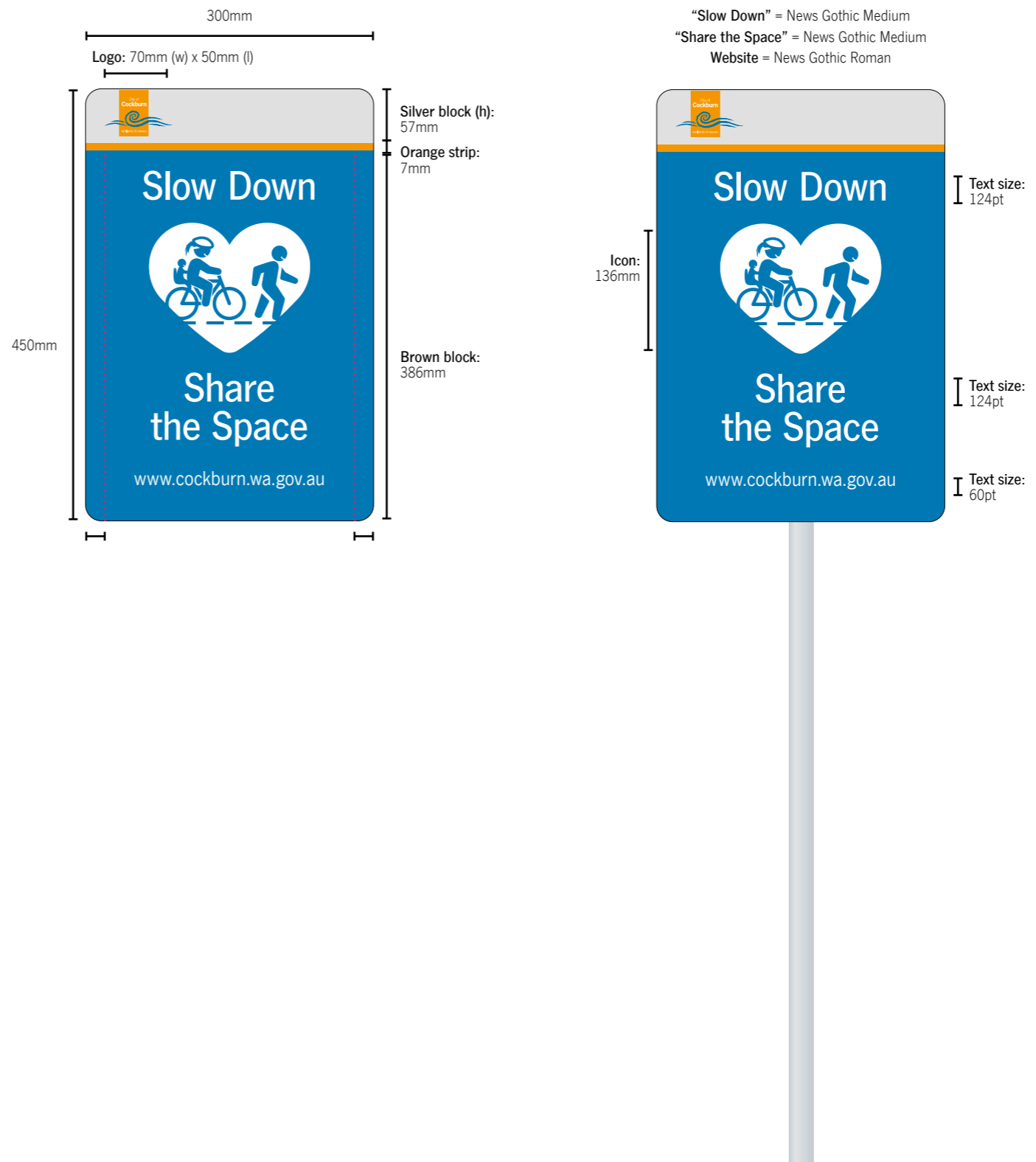

12.0 Waste



12.1 Bin labels

These labels are placed on resident's bins notifying them of non compliance.

Dimensions

See measurements right.

Construction and installation

Decal: Black printing on adhesive label.

Installation: Information on how to install.

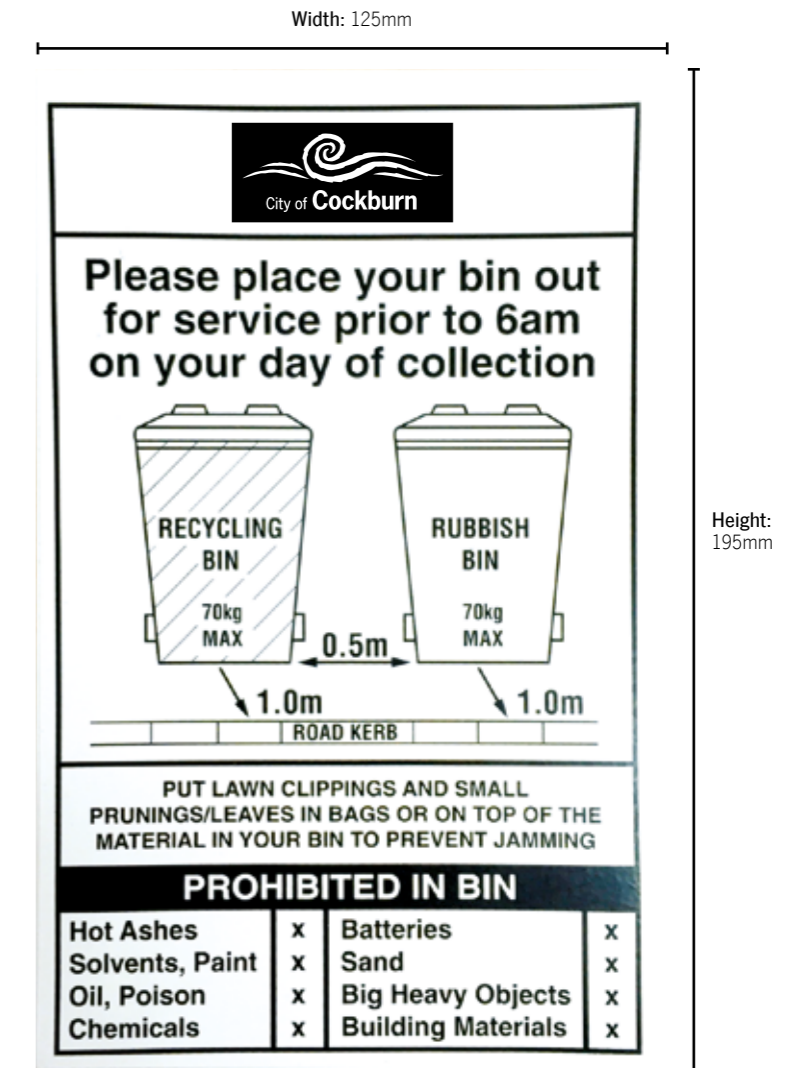
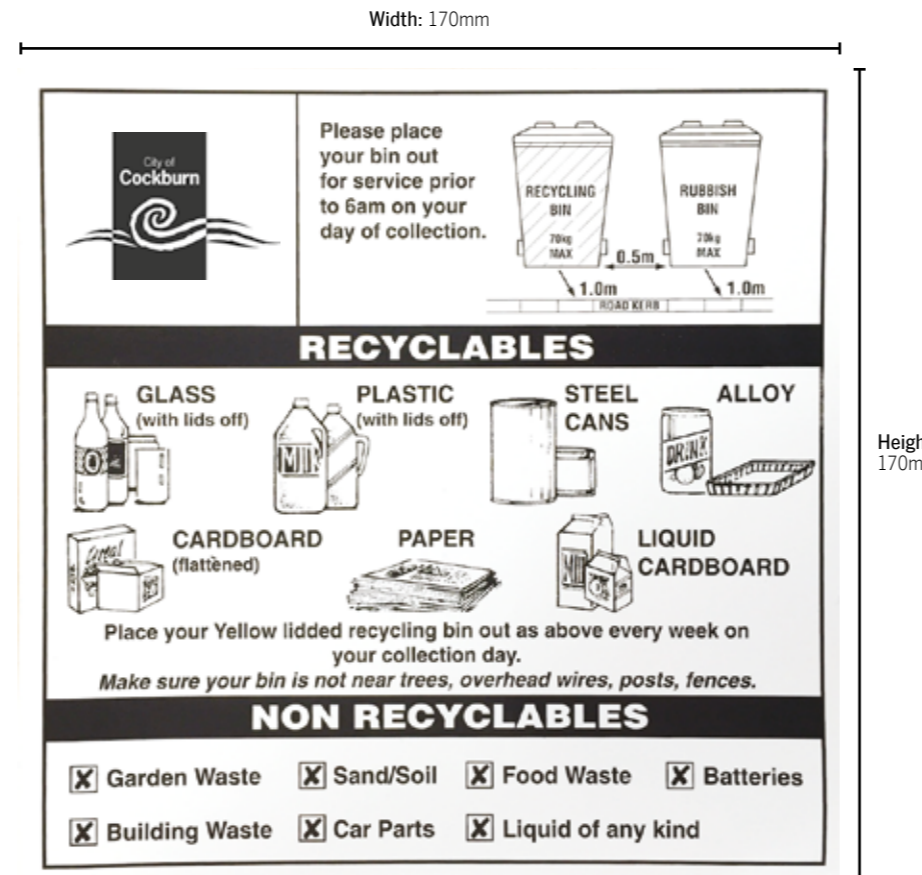

12.2 Rubbish truck signage

Dimensions

See measurements right.

Construction

Decal: Adhesive label.

Note: Label artwork examples shown right are for illustrative purposes only.

General garbage truck



29m³ Recycle truck



13.0 Symbols



13.1 Using symbols

All symbols included in City of Cockburn signage must be Australian Standard (AS). Where there is no AS symbol available, the international standard (ISO) equivalent symbol must be used. (Note: many Australian standard symbols use the ISO equivalent symbol, meaning that the Australian Standard is the same as the international standard.)

The use of AS and internationally recognised symbols on signs ensures simple, concise and consistent messages are conveyed to motorists, visitors and City of Cockburn residents.

For further information on Australian Standards refer to the SAI Global website: www.saiglobal.com

For further information on International Standards refer to the International Organisation for Standardisation website: www.iso.org

The symbols shown (right and overleaf) have been chosen as the standard for all City of Cockburn signage, including:

- directional/wayfinding
- tourism
- public space
- parking
- facilities and public buildings.

Some older signage may use different symbols. These will be phased out gradually as signage is updated and replaced.

Refer to Graphic Designers and marketing if a symbol is required and not included in this document.

All symbols are available in aluminium and plastic forms.

Braille should be used on these signs as per Australian Standards.

Symbols used for City owned building (Interior and Exterior)



Direction Arrow

Indicates direction or movement of people. Only used in conjunction with other symbols.*



Toilets - Unisex

To indicate the location of a public toilet for males and females.*



Full Accessibility Or Toilets Accessible

To indicate routes and facilities with full accessibility.*

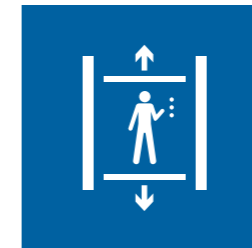

Lift

To indicate the location of a public lift.*



Toilets - Female

To indicate the location of a public toilet for females.*



Stairs

To indicate the location of stairs.*



Toilets - Male

To indicate the location of a public toilet for males.*

*These symbols are sourced from International Standard ISO 7001 (Third edition 2007-11-01).

This section covers interior and exterior identifier and information signage at City owned facilities and buildings, such as public toilets, WiFi facilities, recreation facilities and public services.

Note: not all City owned facilities are included in this document. Refer to Australian Standards AS 1102.101—1989 for guidelines for any building or facility that is not listed.

Toilet and changeroom signage

Signage applied to all toilet and changeroom facilities within the locality must follow these guidelines. This includes facilities within City owned buildings and service centres, public toilets and beach changerooms/toilets. This section does not relate to directional signage for public toilets.

All signage must use the following Australian standard symbols:

It is not necessary to include text, other than in braille, when the above symbols are used. Generally text should be kept to a minimum and must not be used to repeat the message of a symbol for example using the word toilet, male, or female and a symbol is not necessary.

Note: this document specifies new signage only, installed since March 2012. Older toilet and changeroom facility signage may not follow these guidelines. This will gradually be phased out as facility signage is updated. During this transition some old and new signage may co-exist.



Direction Arrow:

Indicates direction or movement of people. Only used in conjunction with other symbols.



Full Accessibility Or Toilets Accessible:

To indicate routes and facilities with full accessibility.



Toilets - Female:

To indicate the location of a public toilet for females.



Toilets - Male:

To indicate the location of a public toilet for males.



Toilets - Unisex:

To indicate the location of a public toilet for males and females.

13.2 General toilet/changeroom signage

Usage

Braille should be used on these signs as per Australian Standards

Dimensions

Sign face: 180mm (w) x 180mm (h) standard size

Other sizes may be used if appropriate, for example see next page.

Overall height: Signs should be positioned as specified in AS 1428.

Construction and installation

Sign face: 2mm aluminium panel.

Graphics: Premium grade cut applied to face and to wrap edges.



Female toilet/changeroom



Unisex toilet/changeroom



Male toilet/changeroom



Disabled toilet/changeroom

13.3 Leisure centre toilet/changeroom signage

These signs differ from the standard size format (shown on the previous page) due to the inclusion of the directional arrow and a larger family symbol.

All of these signs include an area for braille text, indicated by the white dotted line.

Dimensions

Sign face: 250mm (w) x 200mm (h)

Overall height: Approx 1200mm from ground level.

Construction and installation

Sign face: 2mm aluminium panel.

Graphics: Premium grade printed vinyl applied to face with UV anti-graffiti laminate over. Braille characters overlaid in section below symbol.

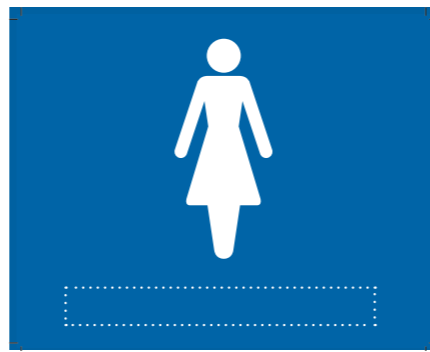

Female toilet/changeroom

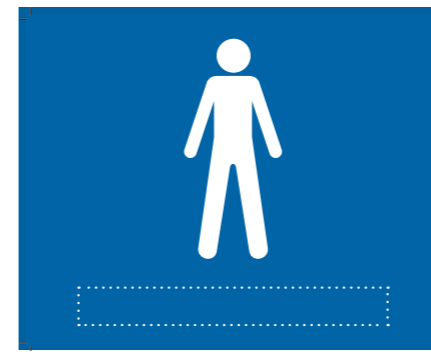

Male toilet/changeroom

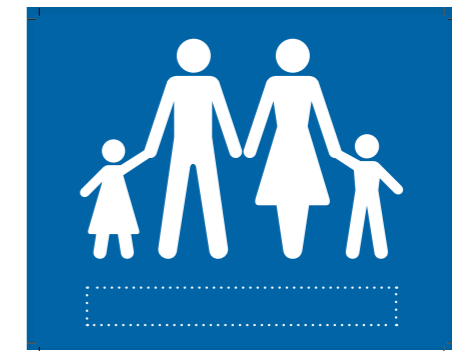

Family toilet/changeroom



Female toilet/changeroom - Right

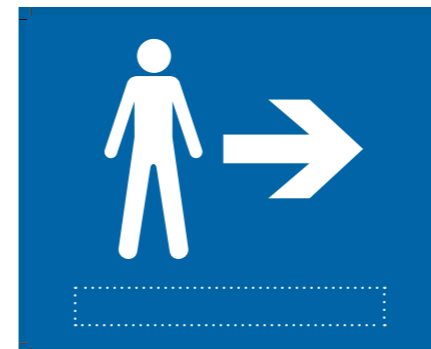

Male toilet/changeroom - Right



Disabled toilet/changeroom



Female toilet/changeroom - Left

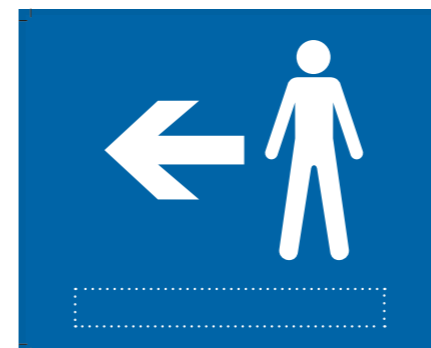

Male toilet/changeroom - Left

13.4 Symbols used for wayfinding including road traffic and pedestrian signage



Aboriginal Attraction
source: National Tourism
 Signing Reference Group



Museum source:
 National Tourism
 Signing Reference
 Group



Bowling club source:
 Cof/Tangelo Creative



Gold Course source:
 National Tourism
 Signing Reference
 Group



Parking source::
 As 1742.6-2004



**School source: Cof/
 Tangelo Creative**



Historic Building
source: National
 Tourism Signing
 Reference Group



Walking Trail
source: National
 Tourism Signing
 Reference Group



Cafe source:
 As 1742.6-2004



Hospital source:
 As 1742.6-2004



Police Station source:
 As 1742.6-2004



Shopping Centre
source: Iso 7001



Lookout source:
 National Tourism
 Signing Reference
 Group



Art Gallery source:
 Cof/Tangelo Creative



Caravan Park source:
 As 1742.6-2004



Library Source:
 Cof/Tangelo Creative



**Port, Ship, Ferry Or
 Boat source:** Iso 7001



**Sporting Activities/
 General Sports**
source: Iso 7001



Monument/Cairns
source: Road Sign
Guidelines: South
 Australia



BandB source:Road
 Sign Guidelines:
 South Australia



**Church source: Cof/
 Tangelo Creative**



Medical Centre
source:
 As 1742.6-2004



Restaurant source:
 Main Roads WA



Surf Live Saving Club
source:Cof/Tangelo
 Creative

13.4 Symbols Used for Wayfinding Including Road Traffic and Pedestrian Signage



Swimming Pool
Source: As
2416.1:2010



World Heritage Area
source: Unesco



Tennis Club
source: Cof/Tangelo
Creative

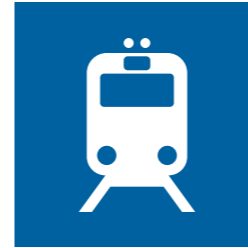

Train Station
source: Main Roads
WA



Visitor Centre - Accredited
source: Main Roads WA



Playground
source: istock
483342129



Shelter/gazebo
Source: gettyimages
1351636108



Bbq Plate
source: gettyimages
1031295046



Share the Space
source: 2020 Share
the Space campaign



Golf Allowed
source: gettyimages
165967283



Two-way Radios
source: City of Cockburn

13.6 Prohibitive icons

Prohibitive pictograms display images which portray instructions with which failure to comply results in breaking the law, in breach of standing orders, or safety procedures. The use of any new pictogram must be approved by Corporate Communications. For symbols shown here please specify the symbol in your request.



13.7 Permit Icons



13.8 Warning Icons

Australian/New Zealand Standard™

Water safety signs and beach safety flags

Part 1: Specifications for water safety signs used in workplaces and public areas (ISO 20712-1 :2008, MOD)



Means of escape and emergency equipment signs



Mandatory action signs



Signage Manual - National Aquatic Recreation - 2006 - Third Edition:
 Docset ID: 10149766
 Water safety signs and beach safety flags
 Part 1: Specifications for water safety signs used in workplaces and public areas
 (ISO 20712-1 :2008, MOD): Docset ID: 10170092

13.9 Dog permission icons

As referenced in the Animal Management and Exercise Plan 2020-2025, the City uses a traffic light style signage system for dog owners.



Dog prohibited area. Dogs are not allowed within the area on or off-leash. Registered assistance dogs are exempted.



Dog on-leash area. Dogs are allowed within the area but must be on-leash unless within an enclosed dog park.



Dog off-leash area. Dogs may be off-leash within the area, but effective control by the owner is still required. Dogs must be tethered if a designated sporting field is in use, City officers are using power tools or mowing, or at the direction of a City officer.



Small Version
(No text)



Dog on leash area on boundary access signage.



Footpath sticker with traffic light style signage system.

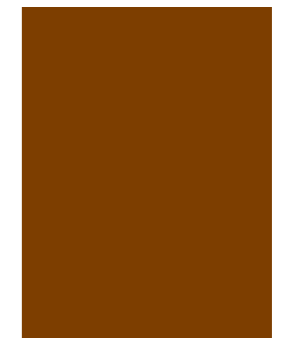

13.10 CCTV icon

The public must be informed that CCTV is in use for security and privacy purposes. Below are signs that notify and display this information.



**CCTV operates
in this area**

Complete version.



CCTV in this area

Concise version – for limited space.



City of Cockburn

Whadjuk Country

9 Coleville Crescent, Spearwood WA 6163

PO Box 1215, Bibra Lake DC WA 6965

08 9411 3444 | customer@cockburn.wa.gov.au

www.cockburn.wa.gov.au